

ADOBE® ENCORE®

Help and tutorials

February 2013



Contents

What's New.....	1
What's new in CS6.....	2
What's new in CS5.....	5
Workflow and workspace.....	7
Workspace basics.....	8
Workflow.....	14
Managing workspaces.....	16
Download full library content/functional content.....	17
Planning the project.....	18
Project planning.....	19
Creating projects and importing.....	24
Projects.....	25
The Resource Central panel.....	28
Aspect ratios.....	29
Adobe Dynamic Link.....	32
The Project panel.....	36
Viewing and editing XMP metadata.....	39
Importing assets.....	42
Transcoding in Encore.....	47
Transcoding presets.....	49
Transcript metadata in Flash output.....	52
Menus.....	53
Menu basics.....	54
Button subpictures.....	61
Creating menus.....	65
Multi-page menus for blu-ray discs.....	68
Using Photoshop to create menus.....	70
Edit and style menus.....	74
Adding text to menus.....	81
Button routing and numbering.....	87
Chapter indexes into linked menus.....	90
Creating styles for menu elements.....	92
Menu color sets.....	94
Menu templates.....	97
Menu timing and looping.....	100
Using After Effects to enhance menus.....	102
Video and audio in menus.....	104

Timelines and slide shows.....	108
Timeline basics.....	109
Create and manage timelines.....	113
Editing assets in timelines.....	116
Chapter points.....	120
Slide show basics.....	122
Audio and subtitles.....	127
Audio clips.....	128
Subtitle basics.....	130
Subtitle scripts.....	134
Subtitle colors.....	139
Navigation for audio and subtitle tracks.....	142
Closed captions.....	144
Creating and managing links.....	145
Playlists and chapter playlists.....	146
Navigation through links.....	149
The Flowchart panel.....	154
Viewer interaction through the remote control.....	159
Testing and building the final product.....	161
Building the finished project.....	162
Exporting projects to Flash format.....	166
Security and additional content.....	173
Keyboard shortcuts.....	175
Using keyboard shortcuts.....	176

What's New

What's new in CS6

- [Native 64-bit support](#)
- [Additional colors in button highlights](#)
- [Chapter PlayList support for Blu-ray and web DVDs](#)
- [DTS HD support for Blu-ray](#)
- [Upper Field First support for DVDs](#)
- [Enhanced color quality in pop-up menus](#)
- [Pixel aspect ratio correction in Preview simulator](#)
- [Additional slides in slideshow](#)
- [Option to Change the Media cache location](#)
- [Performance improvements](#)
- [Web DVD enhancements](#)

Native 64-bit support

[To the top](#)

Encore CS6 is 64-bit native, which enables it to use the entire available RAM on your computer. You can now work more efficiently with complex projects.

Additional colors in button highlights

[To the top](#)

You can now export button highlights with 8 bit indexed colors for blu-ray discs. You can also export button highlights with full colors for web DVDs. To enable the feature, select Export Highlights in Rich Color in the Menu Properties pane.

Chapter PlayList support for Blu-ray and web DVDs

[To the top](#)

Encore CS6 includes new options that provide more flexibility when you play chapter playlists:

- Sequential: Play chapter playlists sequentially.
- Random: Let the player randomly select a set of chapters to play.
- Shuffle: Let the player play all the chapters in any random order.

Encore CS6 provides only the Sequential option for chapter playlists of DVD projects. Find these options in the Chapter PlayList panel. In addition, Encore CS6 supports Random and Shuffle options for chapter playlists in web DVDs.

DTS HD support for Blu-ray

[To the top](#)

You can now import DTS HD files into Encore and build to blu-ray discs. This feature is not supported for rich media and DVD projects.

Upper Field First support for DVDs

[To the top](#)

Enhance video quality by importing a video file in Encore CS6 with the Upper Field First setting. If you transcode the file, Encore CS6 maintains the setting in the transcoded file.

Enhanced color quality in pop-up menus

[To the top](#)

Create better quality pop-up menus for Blu-ray projects using Encore CS6. Encore CS6 uses the indexing algorithm of Photoshop Library to produce better quality images with additional colors.

Pixel aspect ratio correction in Preview simulator

[To the top](#)

Eliminate distortion and clipping of menu button highlights in the Preview simulator. Encore CS6 correctly interprets the pixel aspect ratio (PAR) of menu items in the Preview simulator. Correct PAR interpretation also helps eliminate the black bar.

Additional slides in slideshow

You can now add more than 99 slides in a slideshow for DVD. Encore CS6 accommodates any additional slide you add beyond 99 slides in the last chapter.

Also, Encore CS6 lets you add 999 slides in a slideshow for Blu-ray. Encore CS6 accommodates any additional slide beyond 999 slides in the last chapter. However, you cannot use Manual Advance on your remote for individual slides in the last chapter.

Encore CS6 does not impose any such limitation on the number of slides you can add to a slideshow for web DVDs.

Option to Change the Media cache location

Change the location of the media database from within Encore CS6 for greater flexibility. .

A database retains links to each of the cached media files. This media cache database is shared with Adobe Media Encoder, After Effects, Adobe Premiere Pro, and Soundbooth.

To change the location of the database from within Encore CS6 running on Windows, choose Edit > Preferences > Media.

Performance improvements

Encore CS6 provides several features that help improve system performance.

Faster import of images and slideshows Encore CS6 creates proxy images for the assets only after you render the assets, which reduces the time to import assets.

Less time to save slideshow projects Save slideshow projects faster with the more responsive Encore CS6 graphical user interface (GUI).

Background processing When importing files, Encore CS6 performs indexing and legal checks for DVDs and blu-ray discs in the background, instead of the main thread. Encore CS6 performs indexing only for assets in MPEG 2 format. However, Encore CS6 performs DVD and Blu-ray legal checks for assets in both MPEG 2 and MPEG 4 formats.

Background processing quickly releases system resources to let you import assets in MPEG 2 and MPEG 4 formats faster.

Less time to open projects Encore CS6 stores the encoding status of each imported asset in a cache when it performs legal checks for DVDs and blu-ray discs. While opening a project that contains an imported asset, Encore CS6 quickly fetches its encoding information from the cache. The quick retrieval of encoding information helps reduce the time to open the project.

Timeline scrubbing Scrub a timeline in Encore CS6 without worrying about stuttering in the Preview pane.

Web DVD enhancements

Encore CS6 maintains parity of web DVD with DVD and blu-ray discs. Features that work on blu-ray discs and DVDs also work for web DVD. To be able to play web DVDs, you must have Adobe Flash Player 11 or higher installed on your computer.

Full control over web DVD presets Adjust the bit rate when exporting video to a web DVD using the wide range of Encore CS6 video presets. You can add custom presets or remove a preset. Click the Advanced button in the Edit Quality Presets panel to customize the presets. The custom presets are displayed in the Build panel.

Multi-page menu support Multi-page menus are now available for web DVDs in addition to blu-ray discs.

Multi-page pop-up menu support Create pop-up menus using Encore CS6 and attach them to timelines on a web DVD. Viewers can access the timelines using a remote.

Button autoactivate With Encore CS6, you can configure a blu-ray disc or DVD menu button to activate automatically when you navigate to it. This feature is also available for web DVDs.

End action overrides Dynamically control navigation through a project in Encore CS6 using End action overrides. Encore CS6 supports End action overrides on web DVDs, in addition to blu-ray discs and DVD.

Menu remembers last highlighted button In Encore CS6, a web DVD menu remembers the last menu button that a user highlights.

Menu loopback support Now add loopbacks to a web DVD motion menu in addition to blu-ray discs and DVDs. Menu loopbacks enable the menu to quickly loop from a specific point. The feature is especially useful when a long interval separates the start and end points in a menu.

Button transition After you click a menu button on a web DVD, play a transition for the button before the timeline starts.

Subtitle language setup menu Use this feature to indicate the currently active subtitle track for a web DVD when a menu is displayed.



Twitter™ and Facebook posts are not covered under the terms of Creative Commons.

[Legal Notices](#) | [Online Privacy Policy](#)

What's new in CS5

[Auto-fix subtitle frame gaps for blu-ray discs \(Encore CS5.1\)](#)

[Option to change the media cache location \(Encore CS5.1\)](#)

[Multi-page menus for Blu-ray discs](#)

[Flash DVD enhancements](#)

[Export DDP image to hard disk](#)

[Synchronize timelines with the asset's frame rate and dimensions](#)

[Open and edit projects across platforms](#)

[Set 24p frame rate for Blu-ray projects](#)

[Out-of-process transcoding](#)

[Red 4K import](#)

[AVCHD passthrough](#)

Auto-fix subtitle frame gaps for blu-ray discs (Encore CS5.1)

[To the top](#)

Automatically resize one or both the flanking subtitle clips such that the gap separating them is five frames. The automatic adjustment eliminates chances of errors due to insufficient gaps between subtitle clips, which prevent a blu-ray disc from burning.

Use Auto Fix Subtitle Frame Gaps for all timelines on blu-ray discs, except for timelines with frame dimensions 720x480. For more information, see [Automatically fix subtitle frame gaps for Blu-ray discs](#).

Option to change the media cache location (Encore CS5.1)

[To the top](#)

When importing media files (in certain formats), change the media cache location from within Adobe® Encore® CS5.1 to improve the performance of previews. The flexibility provided by the feature lets you configure the media cache location in a separate machine to offset memory overheads on the production machine.

A media cache database retains links to the cached media files. The database shares the links with Adobe Media Encoder, After Effects, Adobe Premiere Pro, and Soundbooth to let each application use the same media files. Sharing the same cache files ensures database consistency across applications. For more information, see [Set Media preferences](#)

Multi-page menus for Blu-ray discs

[To the top](#)

A multi-page menu is a single PSD file containing multiple pages that are linked to each other. A page is a layer group in the PSD file containing buttons. The buttons link to parts of the menu, or to a chapter point in the timeline. Multi-page menus can be created in Encore, or imported from Photoshop. For more information, see [Multi-page menus for blu-ray discs](#).

Flash DVD enhancements

[To the top](#)

Search text subtitles in Flash DVD. The new Flash DVD player has customizable playback controls that help you readily navigate and search content in the movie. Performance enhancements ensure smoother playback at low bandwidths, and reduced glitch at chapter markers during streaming. For more information, see [Play Flash DVD output files](#).

Export DDP image to hard disk

[To the top](#)

Directly export DDP images to your computer's hard disk, and deliver it to the replication facility using FTP. Delivery through electronic media is faster, and does not involve the extra hardware associated with DLT. For more information, see [Build a DVD or Blue-ray disc](#).

Synchronize timelines with the asset's frame rate and dimensions

[To the top](#)

Encore also allows you to use the same asset in multiple timelines that can have different frame rates or dimensions. In such cases, Encore transcodes these assets for each timeline with the frame rate and dimensions of the timeline in which it is placed.

For assets with different frame rates and dimensions, Encore creates timelines that are synchronized with the asset's properties. The synchronization helps provide real-time playback, and better accuracy in subtitle positioning.

Open and edit projects across platforms

[To the top](#)

Open an Encore project created in Mac on a Windows machine, and the other way round. Also, you can open and edit projects created in Encore CS4 and earlier versions. For more information, see [Open and edit projects across platforms](#).

Set 24p frame rate for Blu-ray projects

[To the top](#)

Encore automatically chooses the relevant 24 fps transcoding preset when you use the Transcode Now option to transcode the asset. For Blu-ray assets that are not legal, the default values for transcoding are used.

Out-of-process transcoding

[To the top](#)

Out-of-process transcoding enables you to transcode assets in the Adobe Media Encoder application in the Transcode Now workflow. When you enable out-of-process transcoding, the Adobe Media Encoder (AME) is launched as a separate process. For more information, see [Out-of-process transcoding](#).

Red 4K import

[To the top](#)

Movie frames shot using Red cameras can be imported into Encore from Premiere Pro at their full resolution (4K) using Dynamic Link. Encore provides an improved quality of playback for these high resolution files.

AVCHD passthrough

[To the top](#)

Encore does not transcode Blu ray legal (as per BD spec) AVCHD files (MTS,M2TS) when building a blu ray. For more information, see [AVCHD passthrough](#).



[Legal Notices](#) | [Online Privacy Policy](#)

Workflow and workspace

Workspace basics

About workspaces

[Dock, group, or float panels](#)

[Resize panel groups](#)

[Open, close, and scroll to panels](#)

[Working with multiple monitors](#)

[Use context, panel, and viewer menus](#)

[Tools panel overview](#)

[Set preferences for workspace](#)

About workspaces

[To the top](#)

Adobe video and audio applications provide a consistent, customizable workspace. Although each application has its own set of panels (such as Project, Metadata, and Timeline), you move and group panels in the same way across products.

The main window of a program is the *application window*. Panels are organized in this window in an arrangement called a *workspace*. The default workspace contains groups of panels as well as panels that stand alone.

You customize a workspace by arranging panels in the layout that best suits your working style. As you rearrange panels, the other panels resize automatically to fit the window. You can create and save several custom workspaces for different tasks—for example, one for editing and one for previewing.

 You can use floating windows to create a workspace more like workspaces in previous versions of Adobe applications, or to place panels on multiple monitors.

In these two tutorials Andrew Devis from Creative Cow shows [how to use different workspaces](#), and [how to customize your workspace](#).

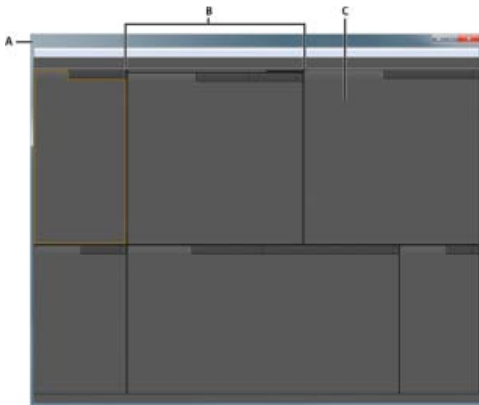

Example workspace

A. Application window **B.** Grouped panels **C.** Individual panel

Dock, group, or float panels

[To the top](#)

You can dock panels together, move them into or out of groups, and undock them so they float above the application window. As you drag a panel, *drop zones*—areas onto which you can move the panel—become highlighted. The drop zone you choose determines where the panel is inserted, and whether it docks or groups with other panels.

Docking zones

Docking zones exist along the edges of a panel, group, or window. Docking a panel places it adjacent to the existing group, resizing all groups to accommodate the new panel.

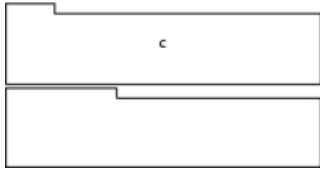
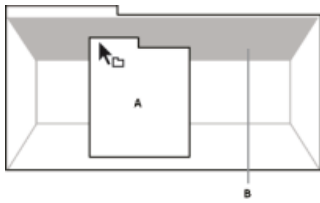

Dragging panel (A) onto docking zone (B) to dock it (C)

Grouping zones

Grouping zones exist in the middle of a panel or group, and along the tab area of panels. Dropping a panel on a grouping zone stacks it with other panels.

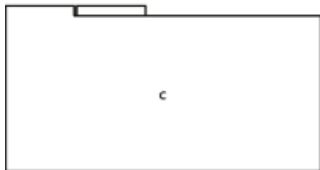
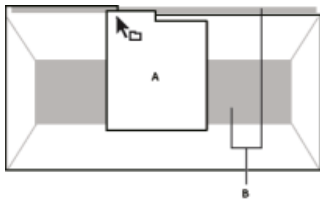

Dragging panel (A) onto grouping zone (B) to group it with existing panels (C)

Dock or group panels

1. If the panel you want to dock or group is not visible, choose it from the Window menu.
2. Do one of the following:
 - To move an individual panel, drag the gripper area in the upper-left corner of a panel's tab onto the desired drop zone.

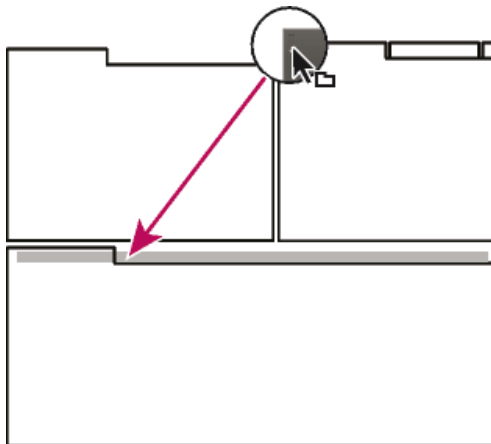

Drag panel gripper to move one panel

- To move an entire group, drag the group gripper in the upper-right corner onto the desired drop zone.

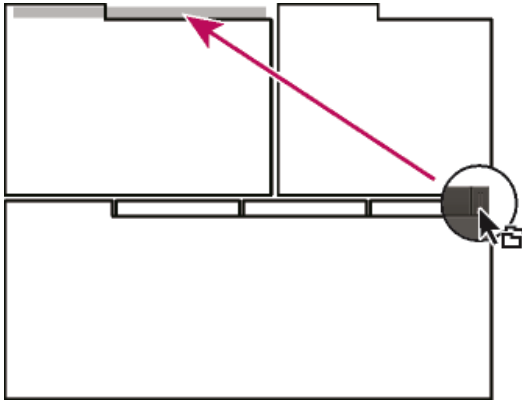

Drag group gripper to move entire group

The application docks or groups the panel, according to the type of drop zone.

Undock a panel in a floating window

When you undock a panel in a floating window, you can add panels to the window and modify it similarly to the application window. You can use floating windows to use a secondary monitor, or to create workspaces like the workspaces in earlier versions of Adobe applications.



- Select the panel you want to undock (if it's not visible, choose it from the Window menu), and then do one of the following:
 - Choose Undock Panel or Undock Frame from the panel menu. Undock Frame undocks the panel group.
 - Hold down Ctrl (Windows®) or Command (Mac OS®), and drag the panel or group from its current location. When you release the mouse button, the panel or group appears in a new floating window.
 - Drag the panel or group outside the application window. (If the application window is maximized, drag the panel to the Windows taskbar.)

[To the top](#)

Resize panel groups

When you position the pointer over dividers between panel groups, resize icons appear. When you drag these icons, all groups that share the divider are resized. For example, suppose your workspace contains three panel groups stacked vertically. If you drag the divider between the bottom two groups, they are resized, but the topmost group doesn't change.

 *To quickly maximize a panel beneath the pointer, press the accent key. (Do not press Shift.) Press the accent key again to return the panel to its original size.*

1. Do either of the following:
 - To resize either horizontally or vertically, position the pointer between two panel groups. The pointer becomes a double-arrow .
 - To resize in both directions at once, position the pointer at the intersection between three or more panel groups. The pointer becomes a four-way arrow .
2. Hold down the mouse button, and drag to resize the panel groups.

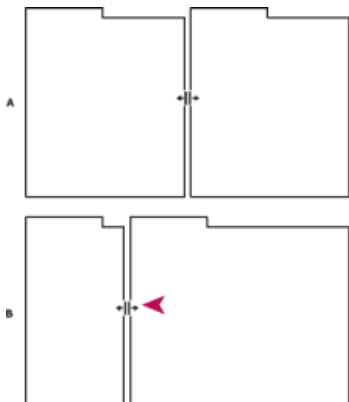

*Dragging divider between panel groups to resize them horizontally
A. Original group with resize icon B. Resized groups*

Open, close, and scroll to panels

When you close a panel group in the application window, the other groups resize to use the newly available space. When you close a floating window, the panels within it close, too.

- To open a panel, choose it from the Window menu.
- To close a panel or window, press Control-W (Windows) or Command-W (Mac OS), or click its Close button .
- To see all the panel tabs in a narrow panel group, drag the horizontal scroll bar.
- To bring a panel to the front of a group of panels, do one of the following:
 - Click the tab of the panel you want in front.
 - Hover the cursor above the tab area, and turn the mouse scroll wheel. Scrolling brings each panel to the front, one after another.
 - Drag tabs horizontally to change their order.
- To reveal panels hidden in a narrow panel group, drag the scroll bar above the panel group.



Drag horizontal scroll bar to see all panels in narrow group

Working with multiple monitors

To increase the available screen space, use multiple monitors. When you work with multiple monitors, the application window appears on one monitor, and you place floating windows on the second monitor. Monitor configurations are stored in the workspace.

Use context, panel, and viewer menus

In addition to the menus at the top of your screen, Encore also provides context, panel, and viewer menus. *Context menus* contain commands relative to the active tool or selection. Panel menus contain commands relevant to the active panel. You use the viewer menus to choose which item to display in the viewer, or to close items.

Use a context or panel menu

- Do one of the following:
 - To use a context menu, position the pointer over the active window or selection and right-click (Windows) or Control-click (Mac® OS). Choose a menu item, or click outside the menu to close it.
 - To use a panel menu, click the triangle in the upper-right corner of a panel, and then choose a menu item or click outside the menu to close it.

Use a viewer menu

Encore provides viewers for its timelines, slide shows, menus, and chapter playlists. *Viewers* are panels in which you edit a type of DVD or Blu-ray element. Slideshow Viewer, for example, lets you edit slide shows. You can set the Encore preferences to specify whether items of the same type open in a single viewer or in multiple viewers. For viewers with multiple items open, use the viewer menu to select the item you want to work with.

- Click the triangle in the Viewer tab, and choose the element you want to work with. You can also close the current item or all the items.

Tools panel overview

You use the Tools panel when working in the Menu Viewer and the Flowchart. It contains tools to select layers or objects in a menu, enter text, zoom in and out, and move objects in the Flowchart. It also contains shortcuts for editing a menu in Photoshop and previewing a project.



Set preferences for workspace

[To the top](#)

You can set numerous preferences for your workspace. These include adjusting the brightness of the user interface and controlling the default television standard used for creating projects.

Set workspace appearance preferences

Appearance preferences include software-wide settings that affect your workspace.

1. Choose Edit > Preferences > Appearance (Windows) or Encore > Preferences > Appearance (Mac OS).
2. Set any of the following options:

Brightness Use the slider to set the brightness of the interface. Click Default to return the brightness to the factory default.

Separate Viewers For Specifies how new timelines, menus, slide shows, and chapter playlists are opened. In Encore, you edit each element type in its own viewer. Timelines, for example, are edited in the Timeline viewer. Select an option to open that element type in a new viewer; deselect an option to open all elements of that type in a single viewer. For example, to open all menus in a single Menu Viewer, deselect Menus. When a single viewer contains more than one item, use its viewer menu to access the desired element. For more information, see [Use a viewer menu](#).

Show Tool Tips Specifies whether tool tips (brief labels or explanations) appear as the pointer moves over tools and other interface elements. This setting is enabled by default.

Beep On Render Completion Specifies whether Encore beeps when it finishes building a project or transcoding a file. Select the option to enable the beep.

Set Media preferences

Media preferences include settings for clearing the Adobe media cache database file and specifying the location for the Encore Library file.

1. Choose Edit > Preferences > Media (Windows) or Encore > Preferences > Media (Mac OS).
2. Set any of the following options:

Library Content Specifies the location of the Library folder for functional content, such as predesigned menus and buttons. Files in this Library folder appear in the Library panel.

Resource Central Content Lets you change the location of the media database from within Encore. When Encore imports audio and video in certain formats, it processes and caches versions of these items for easy access when generating previews.

The media cache improves the performance of previews, because the system does not reprocess audio and video items for each preview. A media cache database retains links to each cached media file. This database is shared with Adobe Media Encoder, After Effects, Adobe Premiere Pro, and Soundbooth.

Each application can read from and write to the same set of cached media files. If you change the location of the database from within any application, the location is updated for the other applications simultaneously. Each application can use its own cache folder. However, the same database tracks all the applications.

Do one of the following:

- To move the media cache or the media cache database, click the corresponding Browse button.
- To remove conformed and indexed files from the cache and their entries from the database, click Clean.

Clean Database Frees up additional disc space by removing old files in the media cache database shared by Adobe audio and video applications. The database tracks media accelerator files that improve performance and speed. For example, if Adobe Premiere Pro creates a conformed audio file, and you import media with that audio into Encore, Encore uses the file from Adobe Premiere Pro instead of creating a new conformed file. The media cache database informs Encore of the conformed file's location.

Write XMP IDs to Files On Import Automatically inserts a unique document ID into each imported file. These IDs ensure that all Adobe Production Premium applications access the same cached previews and conformed audio files, preventing

additional rendering and conforming. This is a global setting—a change in one Production Premium application affects all the others. This setting also results in new file modification dates when IDs are initially inserted.

 *To save rendering time when transferring a project to another machine, move both cached and original files.*

Set General preferences

General preferences include default settings for the software regardless of the project you're working on.

1. Choose Edit > Preferences > General (Windows) or Encore > Preferences > General (Mac OS).
2. Set any of the following options:

Default Television Standard Specifies the default TV standard (either NTSC or PAL) for new projects. Encore determines the default setting according to the operating system's language.

Playback Quality Specifies the playback quality for the Preview and Monitor panels, as well as thumbnails. Select the desired setting from the menu: High to display video at full resolution; Draft to display video at one-half resolution; and Automatic to use draft quality for playback, which changes to high quality when the playback is paused or stopped.

Desktop Display Mode (Windows only) Sets one of three options for playback through a graphics display card:

Compatible Displays video on the desktop in a nonaccelerated manner. This mode is appropriate for use on a graphics card that does not support Direct3D 9.0 acceleration. This option is the lowest-performance display mode.

Standard Uses hardware capabilities on Direct3D 9.0-capable graphics cards to accelerate video playback on the desktop.

Accelerated GPU Effects Uses advanced hardware features present in the newest generation of Direct3D 9.0-capable graphics cards to accelerate video playback as well as several effects on the desktop.

Reset Warning Dialogs Enables all dialog boxes that you previously disabled by selecting Don't Show Again.

 Twitter™ and Facebook posts are not covered under the terms of Creative Commons.

[Legal Notices](#) | [Online Privacy Policy](#)

Workflow

Encore lets you create many different kinds of projects for DVDs, Blu-ray discs, or interactive Adobe Flash® files. Whether the content is a feature film, a wedding, a training course, or an art collection, the basic steps for creating a project are the same.

Note: For a video tutorial about creating projects in Encore, see www.adobe.com/go/vid0239. For an overview of Encore, see www.adobe.com/go/lrvid4226_enc.

Although the order of the tasks can vary somewhat from project to project, authoring with Encore involves the following basic tasks:

Plan the project

Regardless of the project's complexity, it is helpful to plan the content and flow of your project. Whether you sketch each of the elements, create a flowchart, or use a spreadsheet to map the path through the content, drafting a navigation scenario can help you clarify your ideas and anticipate problems before you start. For information, see [About planning](#).

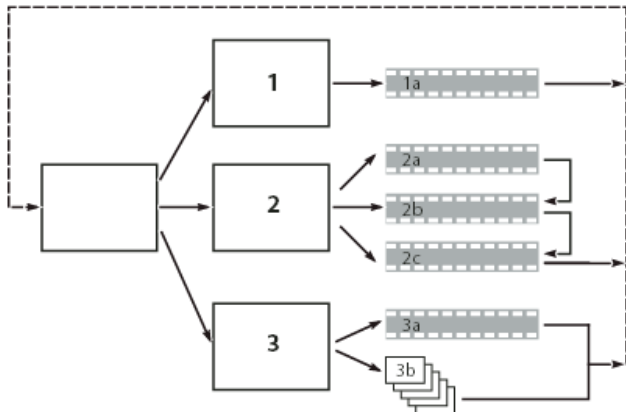

Simple sketch of intended navigation scheme

Import assets

Prepare your source material (assets) for the project, and import them into Encore. The assets include any video, still images, audio, and subtitles for your project. You can import Adobe Premiere® Pro sequences without rendering them through the Adobe Dynamic Link. For information, see [Import assets and menus](#).

Create project elements and add assets

An Encore project includes element types such as timelines and slide shows. You add assets to these elements to include the assets in the project. Depending upon an asset's type, you can add it to timelines, slide shows, menus, playlists, and chapter playlists. For information, see [About timelines](#), [About slide shows](#), [Playlists](#), and [Chapter playlists](#).

Create menus

The menus give the viewer access to the content. You can create menus directly in Encore, customize predesigned menus included with the software, or create and edit menus in Adobe Photoshop®. For information, see [About menus](#).

Specify navigation

Menus provide the main way for viewers to navigate through the content. In addition to menus, you also use other types of navigation settings, such as end actions and overrides, to guide the viewer. Encore gives you several methods for setting the navigation—you can drag between the elements and buttons in Menu Viewer, use the Properties panel, or work with navigation in Flowchart. For a typical project, you'll set navigation with all of these methods, choosing whichever is most convenient at the time. For information, see [Project navigation and links](#).

Make video and audio compatible (transcoding)

If you imported video and audio files that aren't DVD or Blu-ray Disc-compatible, Encore transcodes the files before you burn the disc. You can let Encore determine the best settings for transcoding or select the options you feel are best for your project. For information, see [About transcoding](#).

Preview the project

You should preview and check a project throughout the authoring process, especially before you burn the disc. Previewing lets you experience the project as a viewer would, using the remote control to move through it. The Check Project feature verifies technical details and informs you of any problems, such as broken links or invalid end actions. For information, see [Preview a project](#), and [Check a project](#).

Burn the disc

You can build and burn the DVD or Blu-ray disc directly from Encore. Or, if you plan to use a replication facility, you can write to a DLT drive, prepare a folder, or create a DVD or Blu-ray image to give to the replicator. For information, see [Build a DVD or Blu-ray disc](#).

Export to Flash format

You can export your final projects to a Flash format for interactive viewing on the web. For information, see [Exporting projects to Flash format](#).

More Help topics

[Create Encore projects video](#)



[Legal Notices](#) | [Online Privacy Policy](#)

Managing workspaces

[Choose a workspace](#)
[Save, reset, or delete workspaces](#)

Choose a workspace

[To the top](#)

Each Adobe video and audio application includes several predefined workspaces that optimize the layout of panels for specific tasks. When you choose one of these workspaces, or any custom workspaces you've saved, the current workspace is redrawn accordingly.

❖ Open the project you want to work on, choose Window > Workspace, and select the desired workspace.

Save, reset, or delete workspaces

[To the top](#)

Save a custom workspace

As you customize a workspace, the application tracks your changes, storing the most recent layout. To store a specific layout more permanently, save a custom workspace. Saved custom workspaces appear in the Workspace menu, where you can return to and reset them.

❖ Arrange the frames and panels as desired, and then choose Window > Workspace > New Workspace. Type a name for the workspace, and click OK.

Note: (After Effects, Premiere Pro, Encore) If a project saved with a custom workspace is opened on another system, the application looks for a workspace with a matching name. If it can't find a match (or the monitor configuration doesn't match), it uses the current local workspace.

Reset a workspace

Reset the current workspace to return to its original, saved layout of panels.

❖ Choose Window > Workspace > Reset workspace name.

Delete a workspace

1. Choose Window > Workspace > Delete Workspace.
2. Choose the workspace you want to delete, and then click OK.

Note: You cannot delete the currently active workspace.



[Legal Notices](#) | [Online Privacy Policy](#)

Download full library content/functional content

Extract library content

Link Encore with library content

To obtain the entire library content, click the desired locale and download the .zip file to a location on your computer.

- [English](#)
- [French](#)
- [German](#)
- [Japanese](#)
- [Italian](#)
- [Spanish](#)
- [Korean](#)

To use the library content within Encore, extract the contents of the downloaded .zip file and then link Encore with the extracted content.

Extract library content

[To the top](#)

Extract the downloaded .zip file. A .7z file (for example en-US.7z) is created.

1. Depending upon your operating system, download the appropriate unzip utility:
 - Windows: 7-zip (visit <http://www.7-zip.org/download.html>)
 - Mac OS: Mac unarchiver (visit <http://wakaba.c3.cx/s/apps/unarchiver.html>)
2. Using the unzip utility, extract the contents of the .7z file to a location on your computer. Based on your locale, a folder containing the extracted library content is created (for example en-US).

Link Encore with library content

[To the top](#)

Do one of the following:

- Depending upon your operating system, copy the Library, main, Styles, and Template folders from the folder containing the extracted library content to the appropriate location:
 - Windows: C:\Program Files\Adobe\Adobe Encore CS6\
 - Mac OS: Applications/Adobe Encore CS6/
- Launch Encore and link the library to the location where you extracted the library content:
 - Mac OS: Select Encore > Preferences > Media. Browse to the Library folder of the extracted library content, and then click Ok.
 - Windows: Select Edit > Preferences > Media. Browse to the Library folder of the extracted library content and then click Ok.

Keywords: download library content, download functional content, library content, functional content, full library content, full functional content

 Twitter™ and Facebook posts are not covered under the terms of Creative Commons.

[Legal Notices](#) | [Online Privacy Policy](#)

Planning the project

Project planning

Planning the content

Balancing file size and quality

Bit budgeting

You can design, author, and build media projects in Adobe® Encore® for high-definition Blu-ray Disc and standard-definition DVD. Encore gives you options to burn directly to a disc or other types of output for disc replication. As an added bonus, you can export Blu-ray and DVD projects to Flash format for interactive viewing on the web.

Planning the content

[To the top](#)

About planning

The first task of authoring the project is planning. This planning can be as minimal as deciding to use a template to organize your family's vacation photos and video, or as robust as using project-management software to coordinate a production team creating an interactive kiosk.

Whatever the scope of planning, you should understand what the project will contain and how you want to present it. By the end of the planning stage, you should have a good understanding of the following parameters.

The navigation scheme

A well-produced project employs a hierarchy of navigation that gives the viewer clear and easy access to the content. Think through your project. After you decide which clips you want to include, you need to determine how the viewer will access those clips. Whether you use a spreadsheet or a pencil sketch, it is worth the time to draft your navigation scheme before you start.

The intended playback environment

Is the project intended for television viewing? Will it play unattended in a kiosk? Is it for use in an educational setting on computers? The playback environment affects your approach to navigation and the design of the menus as well as the content. If the project will be used only on a computer (on the desktop or in a web browser), you can include ROM content that a television DVD or Blu-ray player cannot access. For instance, you can include PDFs of exercises in an educational DVD to be used on the computer. If you're planning to export your project to Flash format, you can embed web links that connect your project to other areas in your website.

Types and amount of content to be included

To make certain decisions—for instance, about disc size and video data rate—you need to know how much content you must fit on the disc and what type it is (such as standard-definition or high-definition video). Small projects that include mostly audio might fit on a single-layer DVD, whereas projects containing feature-length movies and many supplemental materials might require a dual-layer or dual-sided DVD or a Blu-ray disc.

Planning with the Flowchart

The Flowchart feature provides a visual interface that helps you to plan and manage the creation of the project. Use the Flowchart from the initial stages of the project, when you determine navigation and begin organizing assets.

Note: *If you're new to authoring these types of projects, plan your navigation scheme on paper and start using the Flowchart after you are familiar with the different element types and their properties.*

The Flowchart displays the content of the project graphically, in a tree structure, detailing the navigation between the different elements. This visual representation can help you to see areas where the navigation is cluttered and you want to refine. Beyond providing a visual representation of the project, the Flowchart also lets you perform many authoring tasks, such as setting project navigation.

If your project contains multiple hierarchical objects, use the zoom controls on the flowchart panel to view the relevant parts of the flowchart. In addition, the tool tips show asset names when you hover the mouse over them.

For a video tutorial about using the Flowchart to plan your projects, see www.adobe.com/go/vid0240.

Balancing file size and quality

[To the top](#)

File size and quality

Authoring a DVD or Blu-ray project involves striking a balance between two competing properties: file size and video quality. As quality increases, so does file size. You want to achieve the highest possible quality for your content while keeping the file sizes small enough so that all of the content will fit on the disc. This balance is achieved by manipulating the video content's data rate—either automatically (by letting Encore set the

data rate) or directly (by setting the transcoding settings or using a third-party application).

You determine the optimal data rate through the process of bit budgeting. To understand bit budgeting, you first need to understand the variables involved: disc size, types and amounts of assets (audio, video, and motion menus), and data rates and transcoding. Once familiar with the variables involved, you'll be able to produce a bit budget to guide you in producing high-quality projects that fit within the allotted disc space.

Determining disc size

Before you can prepare a bit budget, you must determine the size of disc on which to distribute your project. Encore can create projects for 25-GB Blu-ray discs and for a variety of DVD disc sizes. The size you choose is based on the amount of video and the replication method.

Typically, a Blu-ray disc can hold 135 minutes of high-definition video using MPEG-2 plus 2 hours of standard-definition bonus material, or it can hold a total of 10 hours of standard-definition content. Encore also supports H.264 encoding for Blu-ray projects, which provides better quality at lower bit rates than MPEG-2 and therefore more video time. Desktop DVD burners use a recordable DVD-5 disc (DVD+/-R), which has a 4.7-GB capacity and can hold approximately 2 hours of high-quality, standard-definition video.

Encore also supports DLT (digital linear tape), which requires a DLT drive connected to your computer, as well as dual-layer DVDs and dual-sided DVDs. Check your DVD recorder's documentation to see if it can create dual-sided or dual-layer discs. If your disc recorder cannot produce these discs, Encore can still create the project files for them, but you'll need to replicate the disc at a replication facility.

When preparing a project for dual-layer or dual-sided DVDs, keep the following information in mind:

Dual-layer disc Encore supports DVD-R DL and DVD+R DL discs; check your recorder's documentation to see what type of DVDs (+R or -R) it requires. To replicate dual-layer DVDs at a replication facility, you first must write your project to two separate DLTs, one tape for each layer of the disc, using the DVD Master output option. (See Build a DVD or Blu-ray disc and Specify a layer break for dual-layer DVDs.)

Note: *Be aware that +R discs may be incompatible with some DVD players. Before duplicating a large quantity of discs, it's worthwhile to create a sample disc and test it on several different DVD players. Replication facilities, whose paramount purpose is duplicating discs, create discs with the widest possible compatibility.*

Dual-sided disc For dual-sided DVDs, you must create two separate projects. If you will replicate the DVDs at an outside facility, use the DVD Master output option to write each project to its own DLT. (See Build a DVD or Blu-ray disc and Replicating discs.)

Dual-sided, dual-layer disc In this case, you need to build two projects, each producing two tapes. The first two tapes represent the two layers of the first project (Side 1). The other two tapes represent the two layers of the second project (Side 2).

Set the disc size for DVD projects

By setting the disc size for your DVD project at the beginning of the authoring process, Encore can calculate how much space is used for each asset you add to the project and how much space remains free.

1. Choose Window > Build.
2. In the Build panel, choose DVD from the Format menu, and scroll down to the Disc Info section.
3. Choose a size from the Size menu. To enter a custom disc size, choose Custom and then type a size in the text box.
4. If you want to create a dual-sided disc, specify which side this project is for.
5. Close the Build panel and save the project.

Check the space remaining on your disc

The Build panel displays the available space and the used space for the specified disc size during the authoring process. The display conveys size information only and has no bearing on quality. Encore calculates the free space using the transcoding data rate (whether it was set automatically or manually). It then combines this estimated bit rate with the actual bit rate of any transcoded clips and, based on the disc size, calculates the space remaining on your disc.

When transcoding assets, Encore attempts to maintain the highest quality (highest data rate) for the amount of video in the project. If you continue to add video to a project, the program lowers the video data rate to squeeze in the additional content. Encore will warn you if quality dips below a certain level once you build the project or run Check Project.

- Choose Window > Build to display the Build panel, and scroll down to the Disc Info section. Encore displays the amounts of used video space, free space, and space used for ROM content. Respectively, the "thermometer" graphic uses blue, white, and green colors to show the amounts.

Asset types and amounts

Of all the content types, the video portion occupies the most disc space. Depending on the data rate, 1 minute of standard-definition video for DVD projects can occupy up to 73.5 MB, at a rate of 9.8 megabits per second (Mbps). One minute of high-definition video for a Blu-ray project

can occupy from 270 to 405 MB (using rates of 36 Mbps and 54 Mbps). One minute of compressed audio, on the other hand, occupies only 11.5 MB. Still menus are negligible in terms of size. (See [Average asset size](#).)

The amount of video in a project directly affects the optimal data rate. You need an accurate tally of the amount of video in a project to develop a bit budget and to choose a disc size. If the project contains 1 hour of video, for example, it can be transcoded at twice the data rate as a project with 2 hours of video content. Although the video content in each project occupies the same amount of disc space, the quality of the hour-long video will be superior (though not necessarily by a factor of 2).

Data rates

Data rates, usually expressed in Mbps (megabits per second, or 1,000,000 bits per second), specify the amount of data contained in an asset stream and directly affect the quality of video. The data rate is used during transcoding to compress the asset. For video assets, the Encore transcode presets use data rates ranging from 15 to 40 Mbps for Blu-ray projects and from 4 to 9 Mbps for DVD projects. You can edit the presets' data rates, but you cannot exceed 40 Mbps for Blu-ray projects or 9.0 Mbps for DVD projects, nor can you go below the Encore minimum data rate of 2.0 Mbps. Typical data rates for video range between 4 and 6 Mbps. If bit budgeting targets a data rate less than 6 Mbps, consider using variable bit rate (VBR) encoding. For more information about VBR, see [Calculate a bit budget](#).

Although data rates are a general indicator of quality, there are no hard-and-fast rules to equate data rate to quality. That is, a data rate of 4 Mbps may or may not produce a high-quality asset; quality depends on the image data and type of compression used as well as data rate. For example, video of a seated person shot against a solid background can probably be compressed to a lower data rate than a fast-paced car chase with constantly changing visuals, with no noticeable differences in quality.

Bit budgeting

[To the top](#)

About bit budgeting

Bit budgeting, or estimating the amount of space your project will occupy, is an important part of planning. Bit budgeting helps you strike a balance between the quantity and quality of content and determine the optimal video data rate. If your project includes minimal amounts of content, you can encode that content at a higher data rate (which translates to higher quality) to take advantage of all available space. Conversely, if your project contains a large amount of content, you need to use a lower data rate (which translates to lower quality) to squeeze it all onto the disc.

Encore automatically tracks bit budgeting during the authoring process. For small projects with limited content, simply checking the amount of available space on the Build panel during the authoring process is usually sufficient to track your space usage. For large, complex projects, though, bit budgeting becomes much more important to the authoring process, providing a check against the actual data rates achieved.

 *Generally, for projects with less than 2 hours of video, you can skip bit budgeting and let Encore set the data rate automatically.*

Calculate a bit budget

Bit budgeting provides a target video data rate for the project. You can either use a pencil and paper to quickly develop one, or you can create a spreadsheet to do the calculations for you.

 *When bit budgeting for projects to be distributed on 4.7-GB DVDs that contain a single stream of compressed audio, you can use the simplified formula of $560 / x = \text{bit rate in Mbps}$, where "x" represents minutes of video.*

1. Calculate the total disc space available for the entire project.
2. Calculate the disc space available for video. You achieve this by calculating the space required for audio, slide shows, subtitles, and motion menus (other types of content are negligible in terms of bit budgeting), and subtracting that amount from the total disc space. For more information, see [Average asset size](#).

Note: *If you include ROM content, make sure to include it in the space calculation. (See [Add ROM content to the disc](#).)*

3. Calculate the target data rate of the video. You determine this by dividing the amount of space available for video by the amount of video in the project.
4. Determine the maximum video bit rate by subtracting the combined audio and subtitle rate from the data rate limit. (For example, if your combined audio and subtitle rate is 3.0 Mbps, subtracting that from the 9.8 Mbps DVD data rate limit gives you a video rate of 6.8 Mbps.) Your goal is to determine the highest possible target video data rate within the disc data rate limit. If your target data rate is below 6 Mbps, consider using variable bit rate (VBR) encoding. When you use VBR encoding, you specify the maximum video data rate. (The average data rate is the target, but the maximum rate provides some flexibility when encoding.)

Note: *Keep your calculations simple by working with megabits (Mbits) and not megabytes (MB) when bit budgeting. Mbps denotes megabits per second. Also, hard-disk capacity is typically calculated as a power of 2 (1 KB = 2^{10} bytes = 1024 bytes), while optical disc (DVD) capacity is labeled as a power of 10 (1 KB = 10^3 bytes = 1,000 bytes). Use the power-of-10 scheme for bit budgeting. The following conversion factors will aid in the calculations: 1 GB = 10^9 bytes = 1,000,000,000 bytes = 8,000,000,000 bits; 1,000,000 bits = 1 Mbit.*

Average asset size

Use the following averages for bit budgeting:

Audio If compressed using the Dolby® Digital Stereo standard, audio is generally 192,000 bits per second (0.192 Mbps). Use 0.192 Mbps or reference the settings for the audio encoder you plan to use.

Subpictures Insignificant in terms of bit budgeting, unless you include subtitles. If you do include subtitles, use 0.010 Mbps per subpicture stream for calculations.

Motion menus Typically have a data rate of 8 Mbps for the transcoded standard-definition video or 40 Mbps for high definition; add this to the audio data rate. (If the video is already DVD- or Blu-ray-compliant, then it won't be transcoded, and you should use the data rate of the video file.)

Still menus Typically insignificant in terms of bit budgeting and can usually be left out of the calculation. Still menus average 230 KB in size.

Slide shows The asset size for a slide show depends on whether you include transitions or the Random Pan & Zoom effect:

- If the slide show contains no transitions or effects, the slides are written to the disc as MPEG stills, which require minimal space. Stills average 230 KB in size, which is typically negligible for bit budgeting. If you have a large number of images, however, you should include them in your calculation.
- If the slide show includes transitions, then Encore writes both stills and transcoded MPEG video files for the transitions. For example, if a given image appears for 10 seconds, with a 2-second transition at the beginning and the end, then the still is written to the disc (displayed for 6 seconds) as well as two 2-second MPEG video files that contain the transition frames.
- If the slide show includes pan and zoom, then Encore transcodes the stills into an MPEG video file. Slide shows with pan and zoom, in essence, become video content and require the same space allotment as video files. For example, a 5-minute slide show that uses pan and zoom throughout counts as 5 minutes of video content for bit-budgeting purposes.

Sample budget #1

Bit budgeting for a simple DVD project containing 2 hours and 13 minutes of standard-definition video, without any audio, to be distributed on a 4.7-GB disc proceeds as follows:

1. Calculate the total available disc space in bits. A 4.7 GB disc contains 4,700,000,000 bytes; each byte contains 8 bits.
 $4,700,000,000 \times 8 = 37,600,000,000$ bits.
2. Calculate the disc space available for video. Combine the size of the audio, subtitles, motion menus, and 4% of the disc capacity (for overhead, just to be safe), and then subtract that sum from the total available space you calculated in step 1. Since this example has no audio, subtitles, or motion menus, you subtract only the 4% for overhead (1,504,000,000 bits) to get a value of 36,096,000,000 bits.
3. Calculate the data rate of the video. Divide the disc space available for video that you determined in step 2 by the amount of video (in seconds) the project contains. $36,096,000,000 \text{ bits} / (133 \text{ minutes} \times 60 \text{ seconds per minute}) = 4,523,308.27 \text{ bps}$. Divide the bps amount by 1 million bits per Mbit to convert the video data rate to Mbps. $4,523,308.27 / 1,000,000 = 4.5 \text{ Mbps}$.
4. Determine the maximum video data rate. Subtract the combined audio, subtitles, and motion menu data rates, zero in this instance, from the maximum DVD video data rate of 9.8 Mbps. $9.8 \text{ Mbps} - 0 = 9.8 \text{ Mbps}$. Because this is very close to the maximum rate for DVD, you can lower it to 9.0 Mbps to be safe.

The video will fit on the disc using a data rate of 4.5 Mbps. This data rate (4.5 Mbps) is low enough (below 6 Mbps) that you should use VBR encoding. The maximum video data rate for VBR encoding is 9.0 Mbps.

Sample budget #2

Proceed as follows for bit budgeting of a 120-minute standard-definition video with three audio tracks, two subtitle tracks, two motion menus, and a 1-minute movie preview to be burned to an 8.54-GB DVD:

1. Calculate the total available disc space in bits. An 8.54-GB disc contains 8,540,000,000 bytes; each byte contains 8 bits.
 $8,540,000,000 \times 8 = 68,320,000,000 \text{ bits} = 68,320 \text{ Mbits}$.
2. Calculate the disc space available for video. Combine the size of the audio, subtitles, motion menus, movie preview, and 4% of the disc capacity (for overhead, just to be safe), and then subtract that sum from the total available space you calculated in step 1.
 - Three 120-minute audio streams, two with a data rate of 0.192 Mbps, and one with a rate of 0.448 Mbps: $2 \times (120 \text{ minutes} \times 60 \text{ seconds per minute} \times 0.192 \text{ Mbps}) + (120 \text{ minutes} \times 60 \text{ seconds per minute} \times 0.448 \text{ Mbps}) = 5,990.4 \text{ Mbits}$.
 - Two subtitles with a data rate of 0.010 Mbps: $2 \times (120 \text{ minutes} \times 60 \text{ seconds per minute}) \times 0.010 \text{ Mbps} = 144 \text{ Mbits}$.
 - Two 24-second motion menus with an estimated data rate of 8 Mbps: $2 \times (24 \text{ seconds} \times 8 \text{ Mbps}) = 384 \text{ Mbits}$.

- One-minute movie preview with a data rate of 4.5 Mbps: 60 seconds x 4.5 Mbps = 270 Mbits.
 - 4% overhead: $0.04 \times 68,320,000,000 \text{ bits} = 2,732,800,000 \text{ bits} = 2,732.8 \text{ Mbits}$.
 - Total audio, subtitles, motion menus, preview, and overhead sizes: $5,990.4 \text{ Mbits} + 144 \text{ Mbits} + 384 \text{ Mbits} + 270 \text{ Mbits} + 2,732.8 \text{ Mbits} = 9,521.2 \text{ Mbits}$.
 - Disc space available for video: $68,320 \text{ Mbits} - 9,521 \text{ Mbits} = 58,799 \text{ Mbits}$.
3. Calculate the data rate of the video. Divide the disc space available for video that you determined in step 2 by the amount of video (in seconds) the project contains: $58,799 \text{ Mbits} / (120 \text{ minutes} \times 60 \text{ seconds per minute}) = 8.16 \text{ Mbps}$.
 4. Determine the maximum video data rate. Subtract the combined audio and subtitles data rates from the maximum DVD video data rate of 9.8 Mbps: $9.8 \text{ Mbps} - (0.192 + 0.192 + 0.448 + 0.010 + 0.010) = 8.95 \text{ Mbps}$.
The video will fit on the disc using a data rate of 8.16 Mbps, which is below the maximum video data rate of 8.95. Furthermore, because the target video data rate of 8.16 Mbps is above 6 Mbps, you do not need to use VBR.

Sample budget #3

Here is an example of a bit budget for a Blu-ray Disc project that contains 2 hours and 7 minutes of high-definition (HD) video and audio, one 30-second HD motion menu with 30 seconds of audio, and one HD pan-and-zoom slide show containing 50 slides and 8 minutes of audio (total slide show duration is 8 minutes), to be distributed on a 25-GB disc:

1. Total available disc space is 24.5 GB (25-GB disc capacity minus a very conservative 2% overhead of 0.5 GB).
2. Space required for the audio, motion menu, and slide show:
 - 127-minute audio stream with a data rate of 0.192 Mbps = $127 \text{ minutes} \times 60 \text{ seconds} \times 0.192 = 1,463.04 \text{ Mbits}$; divided by 8 bits = 182.88 MB, rounded off to 183 MB.
 - 30-second menu audio stream = $30 \text{ seconds} \times 0.192 \text{ Mbps} = 5.76 \text{ Mbits}$; divided by 8 bits = 0.72 MB, rounded off to 1 MB.
 - 8-minute slide show audio stream = $8 \text{ minutes} \times 60 \text{ seconds} \times 0.192 \text{ Mbps} = 92.16 \text{ Mbits}$; divided by 8 bits = 11.52 MB, rounded off to 12 MB.
 - 30-second motion menu at 40 Mbps = 1,200 Mbits; divided by 8 bits = 150 MB.
 - 8-minute slide show video (all pan and zoom) at 20 Mbps = $8 \text{ minutes} \times 60 \text{ seconds} \times 20 \text{ Mbps} = 9,600 \text{ Mbits}$; divided by 8 bits = 1,200 MB or 1.2 GB.
 - Total disc space required = $183 \text{ MB} + 1 \text{ MB} + 12 \text{ MB} + 150 \text{ MB} + 1,200 \text{ MB} = 1,546 \text{ MB}$ or 1.546 GB.
3. Calculate amount of disc space available for video by subtracting the total disc space required in step 2 from the total available disc space in step 1:
 - $24.5 \text{ GB available space} - 1.546 \text{ GB required} = 22.954 \text{ GB available for video}$.
4. Calculate the data rate of the video by dividing the disc space available for video (in step 3) by the amount of video (in seconds) the project contains.
 - $183,632 \text{ Mbits available} (22.954 \text{ GB} \times 1,000 \text{ MB/GB} \times 8 \text{ bits per byte})$ divided by 7,620 seconds of video ($127 \text{ minutes} \times 60 \text{ seconds per minute}$) = 24.10 Mbps.
 - 127 minutes of video at 24.10 Mbps = 22.96 GB.
($127 \times 24.10 \times 60 \text{ seconds} = 183,642 \text{ Mbits}$, divided by 8 = 22,955.25 MB, divided by 1,000 = 22.96 GB).
5. Determine the maximum video data rate for this project by subtracting the combined audio data rates from the disc's maximum video data rate of 40 Mbps.
 - $40 \text{ Mbps} - 0.576 \text{ Mbps} (0.192 + 0.192 + 0.192) = 39.424 \text{ Mbps}$

So the video will fit on the disc using the video data rate of 24.10 Mbps, which is below the maximum video data rate of 39.424 Mbps.

- [Flowchart planning video](#)

Creating projects and importing

Projects

About projects

Open and edit projects across platforms

Create and open projects

Move or rename projects

About projects

[To the top](#)

Adobe® Encore® files are called projects. A project stores links to all the content you intend to include, as well as the menus and timelines (which combine video or stills, audio, and subtitles). Encore creates a folder for your project in the same location as the project file.

You can create projects for playing on standard-definition DVDs and for playing on high-definition Blu-ray discs. You can author a project for Blu-ray and then output a standard-definition version of the same project to DVD, or vice versa. The Project Settings dialog box lets you easily switch between authoring modes. Once authoring is complete, you can build your projects for final output onto a disc, in a folder, or as an image. In addition, you can export any project into a Flash format for interactive viewing on the web. For a video tutorial on authoring for Blu-ray discs, see www.adobe.com/go/lrvid4079_enc.

A project must conform to one of two TV standards, either NTSC (National Television Standards Committee) or PAL (Phase Alternating Line). TV standards are the specifications to which any video intended for broadcast in a certain country or region must conform. These specifications include specific frame rate and frame size requirements of the video. Your final output from Encore will comply with one of these standards.

TV standard	Blu-ray Disc frame rate	Blu-ray Disc frame size	Aspect ratio	Regions
NTSC	23.976p 24p 29.97i 59.94p	720 x 480 pixels 1280 x 720 pixels 1440 x 1080 pixels 1920 x 1080 pixels	4:3 or 16:9	North America, Japan
PAL	25i 50p	720 x 576 pixels 1280 x 720 pixels 1440 x 1080 pixels 1920 x 1080 pixels	4:3 or 16:9	Europe

TV standard	DVD frame rate	DVD frame size	Aspect ratio	Regions
NTSC	29.97 fps	720 x 480 pixels	4:3 or 16:9	North America, Japan
PAL	25 fps	720 x 576 pixels	4:3 or 16:9	Europe

Note: The preceding table specifies output requirements. Requirements for imported assets vary. See [Supported file formats for import](#).

Set 24p frame rate for Blu-ray projects

Encore automatically chooses the relevant 24 fps transcoding preset when you use the Transcode Now option to transcode the asset. For Blu-ray assets that are not legal, the default values for transcoding are used.

When you create a Blu-ray NTSC-compliant project, you can change the default transcoding settings to a frame rate of 24. You can configure the frame rate for an entire project in the New Project dialog box when you create a project.

1. Do one of the following:

- Click New Project in the startup screen.
- Select File > New > Project.

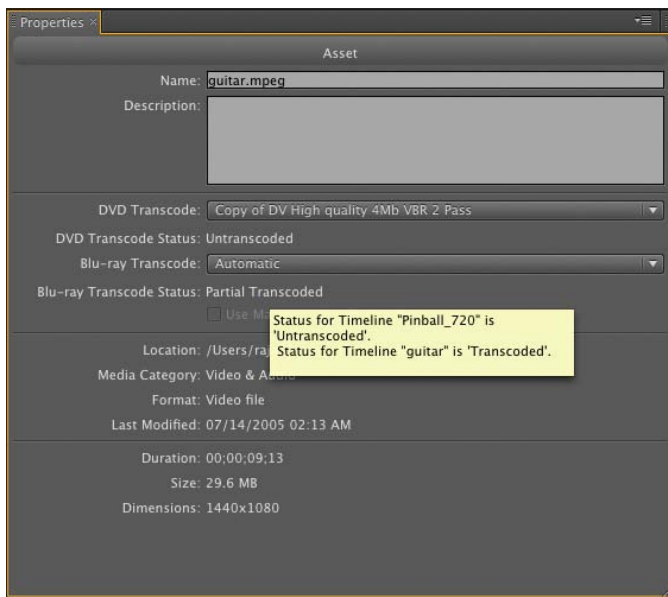

2. In the New Project dialog box, select the following under Project Settings:
 - Authoring Mode: Blu-ray
 - Television Standard: NTSC
3. Click Default Transcode Settings.
4. In the Video Transcoding group, select 24 from the Frame Rate pop-up menu, and click OK.

In addition to specifying the default transcode settings for the entire project, you can also specify 24p frame rate for each NTSC video asset.

❖ Do one of the following to set the frame rate as 24 for NTSC video assets:

- Select an NTSC video asset in the project, and select File > Transcode Settings.
- Right-click the video asset in the Project panel, and select Transcode Settings from the context menu.

Open and edit projects across platforms

[To the top](#)

Open an Encore project created in Mac on a Windows machine, and the other way round. Also, you can open and edit projects created in Encore CS4 and earlier versions. When copying, ensure that you maintain the relative path between the project file and the project folder.

You might have to retranscode assets for cross-platform projects in the following cases:

- Using a common server to transfer files across Windows and Mac machines.
- Opening projects created in CS4 and earlier versions that contain Blu-ray assets.
- When there are timestamp changes of the transcoded assets, such as when you transfer the assets using FTP.

Create and open projects

[To the top](#)

Before you can import your assets, you need to create or open a project. You can have only one project open at a time. For a video tutorial on creating a project in Encore, see www.adobe.com/go/lrvid4227_enc.

Create a new project

When you create a project, Encore prompts you to select an authoring mode (DVD or Blu-ray) and a default TV standard. You can also assign automatic transcoding settings for the maximum audio/video bit rate and audio transcoding scheme. You can change these settings later by choosing File > Project Settings.

1. Choose File > New > Project.
2. In the Basic tab of the New Project dialog box, type a project name (Encore assigns the extension ".ncor" to the end of the filename) and specify a project location.
3. Select DVD or Blu-ray for the authoring mode, and select a television standard (NTSC or PAL).
4. For Blu-ray projects, select a frame rate, dimensions, and codec.
5. Optionally, in the Advanced tab, do the following:

- Select a Maximum Audio/Video Bitrate value (these data rate values are different for DVD and Blu-ray projects) and an Audio Transcoding Scheme.
- If you have installed third-party cards for video capture and playback, select the player. You can change this setting later. See [Using third-party hardware and player](#)

6. Click OK to create the project file and folder.

Set a default TV standard preference

If you generally create projects using the same TV standard, you can set the default standard (the standard used for new projects) in the Preferences dialog box. A project can conform to only one TV standard.

❖ To set the TV standard preference for new projects, choose Edit > Preferences > General (Windows) or Encore > Preferences > General (Mac OS). Specify your TV standard and click OK.

Open an existing project

- To open an existing project, choose File > Open Project. Navigate to the project you want to open, and click Open.
- To open a recently saved project, choose File > [filename] (Windows) or File > Open Recent Project > [filename] (Mac OS). Encore lists the last five projects (four projects on Mac OS) you saved in the order in which you saved them.

Move or rename projects

[To the top](#)

Each project requires a project file (with the `.ncor` filename extension) that contains links to—and instructions for using—the various assets in the project. Projects also require a project folder (named to match the project and at the same folder level as the project file), which stores previews, transcoded assets, and other files used in the project. You can move a project file and its folder as long as you keep the relative positions the same. If you must rename a project, make sure that you match the new project filename with the new project folder name.

Move a project

❖ To move the project, drag the folder and file to a new location, or copy and paste them in the new location. Make sure that their relative positions remain the same; that is, they should both be in the same parent folder.

Note: *When you open a project file you've moved, a dialog box may appear if the application can't locate specific assets. You can either relink them in the dialog box, select Offline to open the project without them, or select Skip or Skip All to temporarily set the assets offline (so that the next time you open the project, Encore prompts you again to locate the assets). When working with offline assets, use the Locate Asset command to relink them before you build or preview the project.*

Rename a project

❖ To rename the project, select the file and folder in Microsoft® Windows® Explorer or the Mac OS Finder and enter matching names (make sure to leave the `.ncor` extension in the project filename).

More Help topics



[Legal Notices](#) | [Online Privacy Policy](#)

The Resource Central panel

[Search in Resource Central](#)

[Download assets from Resource Central](#)

The Resource Central panel connects you to the latest, dynamically updated content on the Adobe website. With Resource Central, you can access product-related news and tutorials using the Resource Central panel in Adobe Encore®. You can browse through a vast library of templates and other assets that you can download right into your project. Resource Central also helps you get updated information about events and product updates.

Search in Resource Central

[To the top](#)

1. Select Windows > Resource Central Viewer to display the Resource Central panel.
2. Type in your search text and press Enter.
3. Navigate through the search results and click to select the pages that you want to view.

Download assets from Resource Central

[To the top](#)

You can browse through different categories of assets that are dynamically updated in the Resource Central and download the ones you require. You can download assets such as menus in high definition and standard definition.

1. Select Window > Resource Central Viewer to display the Resource Central panel.
2. To search for the assets, do one of the following:
 - Type the asset type that you want to search in the search box and press Enter.
 - Select the asset type from the Resource Central panel.
3. Browse through the assets to select the asset you want to download.
4. Click the down arrow button to download the asset into your project.



[Legal Notices](#) | [Online Privacy Policy](#)

Aspect ratios

Pixel and screen aspect ratios

About still-image pixels

Specify an asset's pixel aspect ratio

Specify the screen aspect ratio

Widescreen content on fullscreen TVs

Pixel and screen aspect ratios

[To the top](#)

Digital video uses two types of aspect ratios: pixel aspect ratios and screen aspect ratios (also referred to as frame aspect ratios). Although related, they describe distinct properties. The pixel aspect ratio describes the pixel dimensions within the screen, while screen aspect ratio details the screen dimension relationship.

Pixel aspect ratios

Pixel aspect ratios describe the width-to-height ratio of the pixels that make up a video or still-image file. Pixels are either square or nonsquare (rectangular). Square pixels have a ratio of 1:1. In the film and video industry, however, the :1 is dropped and ratios are expressed as a single number. The following table lists the nonsquare pixel aspect ratios for the two TV standards for standard-definition video.

TV Standard	Fullscreen pixel aspect ratio	Widescreen pixel aspect ratio
NTSC	0.9	1.22
PAL	1.066	1.422

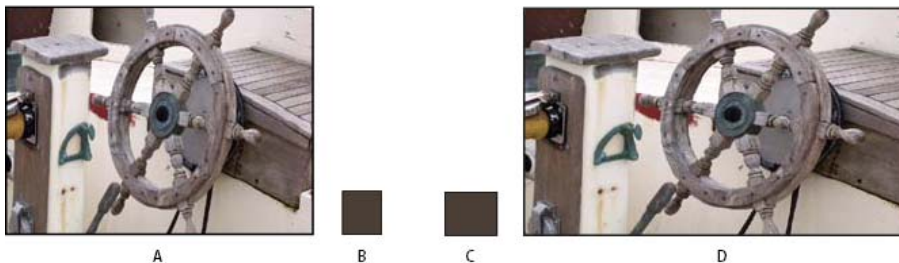

A 720 x 480 pixel image can have a screen aspect ratio of either

A. 4:3, or **D.** 16:9, depending on whether it has a pixel aspect ratio of **B.** 0.9, or **C.** 1.22.

The type of pixels in an image, combined with its dimensions, determine its screen aspect ratio. An NTSC 720 x 480 pixel video, for example, displays as widescreen if it contains nonsquare pixels with a ratio of 1.22. This video displays as a regular 4:3 screen if it contains nonsquare pixels with a ratio of 0.9. Encore lets you specify the pixel aspect ratio of imported assets.

High-definition video and still images have either square 1:1 pixel aspect ratios or a 1.333 anamorphic pixel aspect ratio. They come in three sizes (1280 x 720 or 1920 x 1080 with square aspect ratios, and 1440 x 1080 pixels with anamorphic aspect ratios), and fit in a 16:9 screen aspect ratio.

Screen aspect ratios

Screen aspect ratios (also known as frame aspect ratios) describe the width-to-height ratio of an image or device. A standard television has a 4:3 ratio (referred to as fullscreen), and a widescreen television has a 16:9 ratio. These ratios are also noted as 1.33 for fullscreen ($4 / 3 = 1.33$) and 1.78 for widescreen. (Film, which includes a majority of widescreen content, actually uses screen aspect ratios ranging from 1.66 to 1.85, or even 2.35 for scope footage. However, these all work well within the format and can be considered widescreen.)

The screen aspect ratio is determined by two factors: the resolution of the image and the size of the pixels within it, or the pixel aspect ratio. As the resolution for a given asset is constant (for example, 720 x 480), Encore sets screen aspect ratios based on the asset's pixel aspect ratio.

Note: Assets in a DVD project that share a timeline must have the same aspect ratio. This restriction does not apply to your Blu-ray projects.

About still-image pixels

[To the top](#)

Most digital still cameras and graphic applications use square pixels. You should set the pixel aspect ratio of still-image assets to square to ensure that they display correctly. An exception to this rule are files created in Adobe Photoshop® CS3 and Adobe Photoshop CS2. Photoshop lets you work in nonsquare pixels when creating images for DVDs and video. Use the Photoshop preset that matches your project. For example, if you're working with NTSC DV footage at 720 x 480, you'd use the NTSC DV 720 x 480 (With Guides) preset.

Specify an asset's pixel aspect ratio

You can mix assets with different pixel aspect ratios in the same project. Encore interprets each asset's pixel aspect ratio on import. Occasionally, an asset may contain incorrect information which, in turn, prevents Encore from identifying it correctly. If you need to change an asset's pixel aspect ratio, you can use the Interpret Footage command to specify it.

 *Changing the pixel aspect ratio for a video asset used in a timeline changes that timeline's screen aspect ratio. To change the screen aspect ratio for a still timeline, see [Specify the screen aspect ratio](#).*

1. Select the file in the Project panel.
2. Choose File > Interpret Footage.
3. In the Interpret Footage dialog box, select Conform To, and then choose the appropriate pixel aspect ratio:
 - Square Pixels (1.0) for a standard-definition or high-definition file created using square pixels.
 - SD NTSC (0.9091) or SD PAL (1.0940) for a standard-definition file created using nonsquare pixels with an aspect ratio of 0.9091 (NTSC) or 1.0940 (PAL).
 - SD NTSC Widescreen (1.2121) or SD PAL Widescreen (1.4587) for a standard-definition file created using nonsquare pixels with an aspect ratio of 1.2121 (NTSC) or 1.4587 (PAL).
 - HD Anamorphic (1.333) for a high-definition file created using nonsquare pixels with an aspect ratio of 1.333.
4. Click OK.

Specify the screen aspect ratio

Encore determines the screen aspect ratio for you. You can, however, change it if necessary. The type of asset determines how you specify the screen aspect ratio. For menus, and timelines containing still images but no video, you specify the screen aspect ratio in the Properties panel. For timelines with video, you specify the screen aspect ratio by setting the pixel aspect ratio of the video asset. However, in a DVD project, you must keep the same aspect ratio for the assets that share a timeline.

1. Select the menu or still timeline in the Project panel.
2. Click the desired screen aspect ratio (4:3 or 16:9) in the Properties panel.

Note: *When you change the aspect ratio in the Properties panel, Encore actually changes the asset's pixel aspect ratio, which in turn affects the screen aspect ratio.*

Widescreen content on fullscreen TVs

There are several different methods used to convert widescreen content to 4:3 format for display. Some of the methods convert the widescreen format to fullscreen format and store the converted fullscreen video on the disc. The preferred method stores the original widescreen video on the disc, and the player converts it as necessary during playback to a fullscreen device. Encore stores the original widescreen footage on the disc and instructs the player to letterbox it on playback to a 4:3 TV, regardless of the player's settings.

 *If you're working with widescreen footage, you typically work with and store the content in its widescreen format and let the player convert it during playback.*

DVD players use the following methods to convert widescreen video for display on a 4:3 device:

Pan and scan Crops the widescreen video to fit the fullscreen frame. Pan and scan loses the visual data outside of the 4:3 frame. Traditionally, an editor or technician guides the pan-and-scan process during conversion from film to TV formats. DVD players use an automatic pan and scan. Automatic pan and scan (limited to horizontal tracking of the full height of the picture) crops the image that is stored on the DVD in widescreen format, and displays it on 4:3 devices.

Note: *If a set-top DVD player is set to pan and scan, Encore overrides the player and displays the footage in letterbox format.*

Letterbox Shrinks the image until it fits the 4:3 format horizontally and displays black bars in the blank spaces at the top and bottom of the frame. The resolution of the image is lowered, but the image remains whole—no cropping occurs. DVD players use automatic letterbox to display footage stored as widescreen on 4:3 devices.



A



B



C



D

16:9 NTSC footage

A. Original **B.** Displayed by a DVD player using the original widescreen format on a widescreen TV **C.** Using automatic pan and scan to crop the image on a 4:3 TV **D.** Using automatic letterbox to reduce resolution and display the entire image on a 4:3 TV



[Legal Notices](#) | [Online Privacy Policy](#)

Adobe Dynamic Link

[About Dynamic Link \(Production Premium or Master Collection only\)](#)

[Saving and Dynamic Link \(Production Premium or Master Collection only\)](#)

[Dynamic Link performance \(Production Premium or Master Collection only\)](#)

[Color and Dynamic Link \(Production Premium or Master Collection only\)](#)

[Create a dynamically linked composition from Adobe Premiere Pro or Encore](#)

[Link to an existing composition](#)

[Delete a dynamically linked composition or clip \(Production Premium or Master Collection only\)](#)

[Modify a dynamically linked composition in After Effects \(Production Premium or Master Collection only\)](#)

[Offline compositions and Dynamic Link \(Production Premium or Master Collection only\)](#)

About Dynamic Link (Production Premium or Master Collection only)

[To the top](#)

In the past, sharing media assets among post-production applications has required you to render and export your work from one application before importing it into another. This workflow was inefficient and time-consuming. If you wanted to change the original asset, you rendered and exported the asset again. Multiple rendered and exported versions of an asset consume disk space, and they can lead to file-management challenges.

Dynamic Link, a feature of Adobe Creative Suite Production Premium and Master Collection, offers an alternative to this workflow. You can create dynamic links between After Effects, Adobe Premiere Pro, and Encore. Creating a dynamic link is as simple as importing any other type of asset. Dynamically linked assets appear with unique icons and label colors to help you identify them. Dynamic links are saved in projects generated by these applications.

If you purchase Premiere Pro as a standalone product (which includes Adobe Media Encoder and Adobe Encore), Dynamic Link works between Premiere Pro, Adobe Media Encoder and Encore.

Changes you make in After Effects to a dynamically linked composition appear immediately in the linked clips in Adobe Premiere Pro or Encore. Changes you make to dynamically linked sequences in Adobe Premiere Pro appear immediately in After Effects and Encore. You don't have to render or save changes first.

Online resources about Dynamic Link

For a video tutorial introducing Dynamic Link, see the [Adobe website](#).

John Dickinson provides a video tutorial on the [Motionworks website](#) that shows how to use Dynamic Link between After Effects and Premiere Pro and between After Effects and Encore.

Tim Kolb provides a video tutorial on the [Adobe website](#) that demonstrates the creation of an interactive DVD menu with Premiere Pro and Encore, using Dynamic Link.

Andrew Devis explains how to use Dynamic Link from a Premiere Pro user's perspective [in this video on the Creative Cow website](#).

Learn more about Premiere Pro workflow for Dynamic Link [in this video by Jason Levine](#).

Linking to and from Adobe Premiere Pro

You can send selected clips from Adobe Premiere Pro into After Effects as a composition or nested composition, replacing the clips in Adobe Premiere Pro with a dynamically linked composition.

With Dynamic Link, you can also send sequences from Adobe Premiere Pro into Encore for authoring to DVD, Blu-ray Disc, or SWF files.

In addition to using Dynamic Link, you can share content among applications in any of the following ways:

- copying and pasting between After Effects and Adobe Premiere Pro
- exporting After Effects projects to Adobe Premiere Pro
- using the Capture In Adobe Premiere Pro command in After Effects
- importing Adobe Premiere Pro projects into After Effects

Linking to and from After Effects

When you dynamically link to an After Effects composition from Adobe Premiere Pro or Encore, it appears in the host application Project panel. You can use the dynamically linked composition as you would any other asset. When you insert a linked composition into the host application timeline, a linked clip appears in the Timeline panel. A linked clip is simply a reference to the linked composition in the Project panel. After Effects renders the linked composition on a frame-by-frame basis during playback in the host application.

There are two restrictions on the use of dynamically linked clips between After Effects and Adobe Premiere Pro. Both of these restrictions also apply in reverse: they remain true if you switch composition and sequence:

- If a sequence contains a composition, do not include that sequence, or any sequence in which the sequence is nested, in any dynamic link from the project of the included composition.
- If a sequence contains a composition, do not include links from that composition, or any composition nested in that composition, back to any sequence.

In Adobe Premiere Pro, you can do any of the following with a dynamically linked After Effects composition:

- preview it in the Source Monitor
- set In and Out points for it
- add it to a sequence
- edit it with Adobe Premiere Pro tools

When you add a linked composition that contains both video and audio to a sequence, Adobe Premiere Pro inserts linked video and audio clips in the timeline. You can unlink the video from the audio to edit the clips separately.

In Encore, you can do any of the following with a dynamically linked After Effects composition:

- create a motion menu with it
- insert it into a timeline
- edit it with Encore tools

You can add a linked After Effects composition that contains both video and audio to an Encore timeline. Encore inserts separate video and audio clips in the timeline.

 You can create After Effects compositions from Encore menus, even without Dynamic Link.

Linking to and from Encore

From Encore, you can do any of the following with dynamically linked clips:

- edit a sequence in Adobe Premiere Pro using the Edit Original command
- edit an After Effects composition using the Edit Original command
- update the markers in Encore to match the Encore chapter markers in a sequence in Adobe Premiere Pro

Color and Dynamic Link

After Effects works with the RGB (red, green, blue) color model. Adobe Premiere Pro, however, works with the YUV color model. When you work with a dynamically linked composition, Adobe Premiere Pro either converts it to YUV or retains the RGB colors, depending on the output format.

Dynamically linked compositions are rendered in the color depth of the After Effects project (8, 16, or 32 bpc, depending on project settings). Set the After Effects project color depth to 32 bpc if you're working with HDR (high dynamic range) assets.

 In Adobe Premiere Pro, select a sequence. Then, choose *Sequence > Sequence Settings*. In the *Video Previews* pane, select *Maximum Bit Depth* and *Maximum Render Quality* to have Adobe Premiere Pro process at the highest possible quality. However, these options slow processing.

Saving and Dynamic Link

Save your After Effects project at least once before creating a dynamic link from Adobe Premiere Pro or Encore to a composition within it. After that, you do not have to save changes to the After Effects project to see the changes in a linked composition in Adobe Premiere Pro or Encore.

Using the Save As command to create a copy of an After Effects project does not change dynamic links made to the original project. Adobe Premiere Pro and Encore projects continue to use the original project, not the copy, as the sources for their linked compositions. You can, however, relink a dynamically linked clip to a composition in the copy at any time.

Note: In After Effects, you can choose *File > Increment And Save*. The newly saved open project continues to serve frames to any client projects containing dynamically linked compositions from the open After Effects project.

Saving and Dynamic Link (Production Premium or Master Collection only)

[To the top](#)

You must save your After Effects project at least once before you can create a dynamic link from Adobe Premiere Pro or Encore to a composition within it. However, you don't have to subsequently save changes to an After Effects project to see changes to a linked composition in Adobe Premiere Pro or Encore.

If you use the Save As command to copy an After Effects project that contains compositions referenced by Dynamic Link, then Adobe Premiere Pro or Encore uses the original composition—not the new copy—as its source for the linked composition. You can relink a composition to the new copy at any time.

Dynamic Link performance (Production Premium or Master Collection only)

[To the top](#)

A linked clip can refer to a complex source composition. Actions you perform on the complex source composition require additional processing

time. After Effects takes time to apply the actions and make the final data available to Adobe Premiere Pro or Encore. In some cases, the additional processing time delays preview or playback.

To reduce playback delays, do one of the following:

- take the linked composition offline
- disable a linked clip to temporarily stop referencing a composition
- render the composition and replace the dynamically linked composition with the rendered file

If you commonly work with complex source compositions, try adding RAM or a faster processor.

Note: A linked After Effects composition will not support Render Multiple Frames Simultaneously multiprocessing. See [Improve performance by optimizing memory, cache, and multiprocessing settings](#).

Color and Dynamic Link (Production Premium or Master Collection only)

[To the top](#)

After Effects works with the RGB (red, green, blue) color model. Adobe Premiere Pro, however, works with the YUV color model. When you work with a dynamically linked composition, Adobe Premiere Pro either converts it to YUV or retains the RGB colors, depending on the output format.

Dynamically linked compositions are rendered in the color depth of the After Effects project (8, 16, or 32 bpc, depending on project settings). Set the After Effects project color depth to 32 bpc if you're working with HDR (high dynamic range) assets.

 In Adobe Premiere Pro, choose **Project > Project Settings > Video Rendering**, and select **Maximum Bit Depth** to have Adobe Premiere Pro process at the highest possible quality. However, this option may slow processing.

Create a dynamically linked composition from Adobe Premiere Pro or Encore

[To the top](#)

Creating a new dynamically linked composition from Adobe Premiere Pro or Encore launches After Effects. After Effects then creates a project and composition with the dimensions, pixel aspect ratio, frame rate, and audio sample rate of the originating project. (If After Effects is already running, it creates a composition in the current project.) The new composition name is based on the Adobe Premiere Pro or Encore project name, followed by Linked Comp [x].

1. In Adobe Premiere Pro or Adobe Encore, choose **File > Adobe Dynamic Link > New After Effects Composition**.
2. If the After Effects Save As dialog box appears, enter a name and location for the After Effects project, and click **Save**.
 When you create a dynamically linked After Effects composition, the composition duration is set to 30 seconds. To change the duration, select the composition in After Effects, choose **Composition > Composition Settings**. Click the **Basic** tab, and specify a new value for **Duration**.

Link to an existing composition

[To the top](#)

For best results, match composition settings (such as dimensions, pixel aspect ratio, and frame rate) to the settings in the Adobe Premiere Pro or Encore project.

❖ Do one of the following:

- In Adobe Premiere Pro or Encore, choose **File > Adobe Dynamic Link > Import After Effects Composition**. Choose an After Effects project file (.aep), and then choose one or more compositions.
- In Adobe Premiere Pro or Encore, choose an After Effects project file and click **Open**. Then choose a composition in the displayed dialog box and click **OK**.
- Drag one or more compositions from the After Effects Project panel to the Adobe Premiere Pro Project panel or the Encore Project panel.
- Drag an After Effects project file into the Adobe Premiere Pro Project panel. If the After Effects project file contains multiple compositions, the Import Composition dialog box opens.

Note: You can link to a single After Effects composition multiple times in a single Adobe Premiere Pro project. In an Adobe Encore project, however, you can link to an After Effects composition only once.

If you create a dynamically linked composition from Encore, turn off subpicture highlight layers in After Effects, so that you can control their display in Encore.

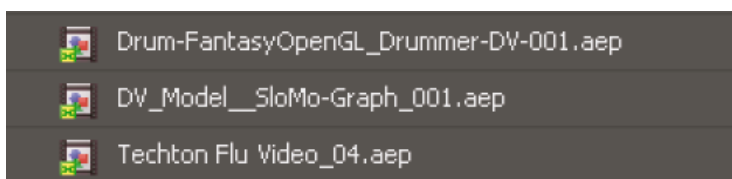

Dynamically linked After Effects compositions

Delete a dynamically linked composition or clip (Production Premium or Master Collection only)

You can delete a linked composition from an Encore project if the composition isn't used in the project. You can delete a linked composition from an Adobe Premiere Pro project at any time, even if the composition is used in a project.

You can delete linked clips from the timeline of an Adobe Premiere Pro sequence or from an Encore menu or timeline at any time.

❖ In Adobe Premiere Pro or Encore, select the linked composition or clip and press the Delete key.

Modify a dynamically linked composition in After Effects (Production Premium or Master Collection only)

Use the Edit Original command in Adobe Premiere Pro or Encore to modify a linked After Effects composition. Once the composition is open in After Effects, you can change the composition without having to use the Edit Original command again.

1. Select the After Effects composition in the Adobe Premiere Pro or Encore Project panel, or choose a linked clip in the Timeline, and choose Edit > Edit Original.
2. Change the composition in After Effects. Then, switch back to Adobe Premiere Pro or Encore to view your changes.

The changes made in After Effects appear in Adobe Premiere Pro. Adobe Premiere Pro stops using any preview files rendered for the clip before the changes.

Note: You can change the name of the composition in After Effects after creating a dynamic link to it from Adobe Premiere Pro. Adobe Premiere Pro does not update the linked composition name in the Project panel. Adobe Premiere Pro does retain the dynamic link, however.

Offline compositions and Dynamic Link (Production Premium or Master Collection only)

Adobe Premiere Pro and Encore display dynamically linked compositions as offline in any of the following circumstances:

- You've renamed, moved, or deleted the After Effects project that contains the composition.
- You've purposely taken the composition offline.
- You've opened the project that contains the composition on a system on which Production Premium or Master Collection isn't installed.
- You're working with a project trimmed by the Adobe Premiere Pro Project Manager. Project Manager does not move the After Effects source compositions to the trimmed project folder. Move the composition manually.

Offline compositions appear with an Offline icon  in the Adobe Premiere Pro Project panel. In Encore, the thumbnail preview displays the Offline icon when an offline asset is selected in the Project panel. If you're working with an offline composition, you can relink it to the original After Effects composition. You can also choose to relink a linked composition to a different source composition.

Take a dynamically linked composition offline

If you are experiencing jerky playback, you can take a dynamically linked composition offline. Also, you can share your project without having to open it on a system with Production Premium or Master Collection installed. You can take a dynamically linked composition offline. When you take a composition offline, you sever the dynamic link with After Effects. The linked composition is replaced in the Project panel with an offline composition.

 You can temporarily suppress a linked clip in Adobe Premiere Pro by selecting the clip and choosing Clip > Enable. To relink the clip, choose Clip > Enable again (a check mark next to the command indicates that the clip is enabled).

1. In Premiere Pro, select the composition in the Project panel.
2. Choose Project > Make Offline.

Relink a dynamically linked composition

❖ Do one of the following:

- In Adobe Premiere Pro, select the composition and choose Project > Link Media. In the displayed dialog box, select an After Effects project. Adobe Premiere Pro automatically relinks the composition.
- In Encore, right-click the composition and choose Locate Asset. In the Locate Asset dialog box, locate the composition you want to link to, and then click Select (Windows) or Open (Mac OS).

The Project panel

[About the Project panel](#)
[Manage the Project panel](#)

[To the top](#)

About the Project panel

The Project panel contains all the audio, video, and still-image assets you can use for a project. It also lists the timelines, menus, slideshows, playlists, and chapter playlists created for the project. Each asset you bring into Encore is identified by a representative icon in the asset list. The list can be customized to group assets into various categories, and to group them into folders you create.

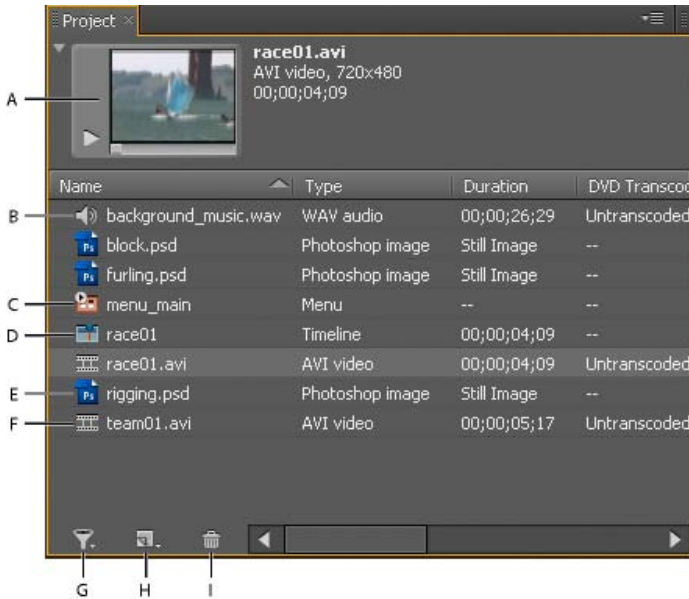

Project panel

A. Preview **B.** Audio **C.** Menu **D.** Timeline **E.** Still image **F.** Video **G.** Toggle display of different item types **H.** Create a new item (If nothing is selected in the Project panel, Encore uses the default assets from the Library panel.) **I.** Delete

When you select an asset, a thumbnail preview appears in the upper-left corner of the Project panel. If the asset contains video or audio, a play controller appears below it so that you can preview the asset. Next to the thumbnail is information about the displayed asset. If you select more than one asset, the text next to the thumbnail indicates the number of assets selected.

Note: You import subtitle script files directly into the timeline in which they belong, not the Project panel. (See [About subtitles in DVD projects.](#))

Project panel columns

The Project panel contains the following columns, which provide information about the assets you've imported. To show or hide any of these columns, right-click (Windows) or Control-click (Mac OS) on a column header and choose a column name from the context menu.

Name Displays the name of the asset or element. You can rename any element.

Type Displays the asset type or element type.

Duration Displays the duration of the asset or element, where applicable, in the format hours; minutes; seconds; frames.

Dimensions Displays the dimensions of the image, in pixels. This field is useful for identifying still-image assets that are not the correct size for the broadcast standard for the project.

DVD Transcode Status Displays the DVD transcoded state of the asset: transcoded or untranscoded.

DVD Transcode Settings This column displays the DVD setting used to encode the asset. (See [About transcoding.](#))

Blu-ray Transcode Status Displays the Blu-ray transcoded state of the asset: transcoded or untranscoded.

Blu-ray Transcode Settings This column displays the Blu-ray setting used to encode the asset. (See [About transcoding.](#))

Size Displays the file size of the asset.

Bitrate Displays the bit rate of the selected asset. (For untranscoded assets, the bit rate is an estimate.)

Media Category Displays the asset type. This category is useful for sorting your assets according to their status as audio or video files, or both.

Description Displays any comments you add to this row. You may type up to 254 characters in the Properties panel.

Last Modified Displays date and time of the last modification to the file.

File Path Displays the system location of the asset. This column is blank if Encore can't find the asset. (See [Locate a missing asset.](#))

[To the top](#)

Manage the Project panel

Customize the Project panel

You can customize the Project panel columns to best suit your working style and needs.

Sort items

❖ Click the column name representing the category by which you want to sort the items. Successive clicks sort them alternately in ascending or descending order.

Hide or show a column

❖ Right-click (Windows) or Control-click (Mac OS) anywhere in a column header, and choose the column you want to hide or show. Alternatively, right-click or Control-click the name of a column, and choose Hide This.

Note: A check mark next to the column name indicates that the column is shown.

Hide or show types of items

❖ Choose the item type from the Toggle Display Of Different Item Types menu  at the bottom of the Project panel.

Resize columns

❖ Position the cursor over the right edge of the column you want to resize, and when the cursor becomes a resize cursor , drag the edge. You can also double-click on the right edge of the column you want to resize. The panel resizes to the length of the longest line of text in that column.

Rearrange columns

❖ Drag the column name to a different location along the column header.

Organize items in the Project panel

To help organize the numerous elements of a project listed in the Project panel, you can group your assets, menus, and timelines into folders. You can nest folders within other folders as well.

Create a folder

- To create a folder at the root level in the Project panel, make sure that nothing is selected, and then choose File > New > Folder.
- To create a folder at a specific level of the hierarchy, select an item currently at that level, and then choose File > New > Folder.
- You can also create a folder by clicking the Create A New Item button at the bottom of the Project panel and choosing Folder from its menu. Type a name for the folder and click OK.

Rename a folder

1. Select a folder in the Project panel, and then choose Edit > Rename.
2. Type a new name, and click OK.

Show or hide the contents of a folder

❖ Click the triangle to the left of the folder icon.

Preview assets in the Project panel

You can preview any asset from the Asset Preview thumbnail in the upper-left corner of the Project panel. Text next to the thumbnail displays the filename and file format of the selected asset. It also displays, if applicable, the duration, image dimensions, and frame rate of the selected asset. If you are previewing video footage, you can either view a particular frame or set the footage to play from any point in its progression.

Note: If a still image (such as a TIFF file) doesn't match the project aspect ratio, Encore crops or mattes it to fit the project's frame size. Using the Still Clip Properties panel, you can control how the image is placed in a timeline, such as whether it is scaled and cropped or matted with black. (See [Scale and crop still images.](#))

Preview a video or audio asset

1. To preview a video or audio asset, select the asset you want to view.
2. Do any of the following:

- To begin playing the asset, click the Play button ▶.
- To pause playback, click the Pause button ⏸.
- To play from a specific location, whether the asset is currently playing or paused, drag the current-time indicator until you reach the location you want to play from. If the preview was paused when you began dragging, click the Play button, and if the preview was playing when you began dragging, stop dragging for playback to resume.

Preview a still asset

- ❖ Select the asset you want to view.

Show or hide the preview thumbnail

- ❖ Click the triangle in the upper-left corner of the Project panel.

Locate a missing asset

If Encore cannot find an asset when you open a project, the Locate Asset dialog box appears. You can then choose to select the missing asset, skip the file, or work offline. Missing or offline assets names appear italicized in the Project panel.

1. Click the Project panel, and select the missing asset.
2. Choose File > Locate Asset.
3. Navigate to the location of the missing asset, select it, and then click Select.

Replace an asset

You can work with offline assets in the Project panel. You can use a placeholder for the offline asset and, when you are ready to work with the actual offline asset, you replace the placeholder with the asset.

1. In the Project panel, select the placeholder asset.
2. Choose File > Replace Asset.
3. Navigate to the location of the asset you want to use as a replacement, select it, and then click Open.

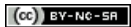

[Legal Notices](#) | [Online Privacy Policy](#)

Viewing and editing XMP metadata

About the Metadata panel and XMP

[Show or hide XMP metadata](#)

[Edit XMP metadata](#)

[Search XMP metadata](#)

About the Metadata panel and XMP

[To the top](#)

To streamline your workflow and organize your files, use XMP metadata. Metadata is a set of descriptive information about a file. Video and audio files automatically include basic metadata properties, such as date, duration, and file type. You can add details with properties such as location, director, copyright, and much more.

With the Metadata panel, you can share this information about assets throughout Adobe video and audio applications. Unlike conventional clip properties, which are limited to only one application's Project or Files panel, metadata properties are embedded in source files, so the data automatically appears in other applications. This sharing of metadata lets you quickly track and manage video assets as they move through your production workflow.

Note: *Properties in the Metadata panel also appear in Adobe Bridge, providing additional details that help you quickly browse assets.*

For a video about the Metadata panel, see the [Adobe website](#).

Maxim Jago explains XMP metadata in a video from, "[Premiere Pro CS5 for Avid Editors](#)."

About schemas and properties

A metadata schema is a collection of properties specific to a given workflow. The Dynamic Media schema, for example, includes properties like Scene and Shot Location that are ideal for digital video projects. Exif schemas, by contrast, include properties tailored to digital photography, like Exposure Time and Aperture Value. More general properties, like Date and Title, appear in the Dublin Core schema. To display different properties, see [Show or hide XMP metadata](#).

 *For information about a specific schema and property, hover the pointer over it in the Metadata panel. For most items, a tool tip appears with details.*

About the XMP standard

Adobe applications store metadata using the Extensible Metadata Platform (XMP). XMP is built on XML, which facilitates the exchange of metadata across a variety of applications and publishing workflows. Metadata in most other formats (such as Exif, GPS, and TIFF) automatically transfers to XMP so you can more easily view and manage it.

In most cases, XMP metadata is stored directly in source files. If a particular file format doesn't support XMP, however, metadata is stored in a separate sidecar file.

Project assets without corresponding files don't support XMP. Examples from Adobe Premiere Pro include Bars and Tone, Universal Counting Leader, Color Matte, Titles, Black Video, and Transparent Video.

 *To customize the creation and exchange of metadata, use the XMP Software Development Kit. For more information about XMP, see [Extensible Metadata Platform](#).*

Show or hide XMP metadata

[To the top](#)

To optimize the Metadata panel for your workflow, show or hide entire schemas or individual properties, displaying only those that you need.

1. From the options menu  for the Metadata panel, select Metadata Display.
2. To show or hide schemas or properties, select or deselect them from the list.

Save, switch, or delete metadata sets

If you use multiple workflows, each requiring different sets of displayed metadata, you can save sets and switch between them.

1. From the options menu  for the Metadata panel, select Metadata Display.
2. Do any of the following:
 - To save a customized set of displayed metadata, click Save Settings. Then enter a name, and click OK.

To display a previously saved set of metadata, select it from the menu.

- To delete a previously saved set of metadata, select it from the menu, and click Delete Settings.

Create schemas and properties

If you have a unique, customized workflow that the default metadata options don't address, create your own schemas and properties.

1. From the options menu  for the Metadata panel, select Metadata Display.
2. Click New Schema, and enter a name.
3. In the list, click Add Property to the right of the schema name.
4. Enter a property name, and select one of the following for Type:

Integer Displays whole numbers that you drag or click to change.

Real Displays fractional numbers that you drag or click to change.

Text Displays a text box (for properties similar to Location).

Boolean Displays a check box (for On or Off properties).

Edit XMP metadata

[To the top](#)

In Adobe video applications, similarly named properties are linked in the Metadata and Project panels. However, the Metadata panel provides more extensive properties and lets you edit them for multiple files simultaneously.

Note: *Instead of a Project panel, Soundbooth uses the Files panel.*



1. Select the desired files or clips.
2. In the Metadata panel, edit text or adjust values as needed.

If you selected multiple items, the panel displays properties as follows:

- If a property matches for all items, the matching entry appears.
- If a property differs, <Multiple Values> appears. To apply matching values, click the text box, and type.

Search XMP metadata

[To the top](#)

1. Select the files or clips you want to search.
2. In the search box at the top of the Metadata panel, enter the text you want to find.
The list of metadata collapses to reveal only properties that contain your search string.
3. (Adobe Premiere Pro only) To navigate through the search results, click the Previous and Next buttons  to the right of the search box, or press Tab.
4. To exit the search mode and return to the full list of metadata, click the close button  to the right of the search box.

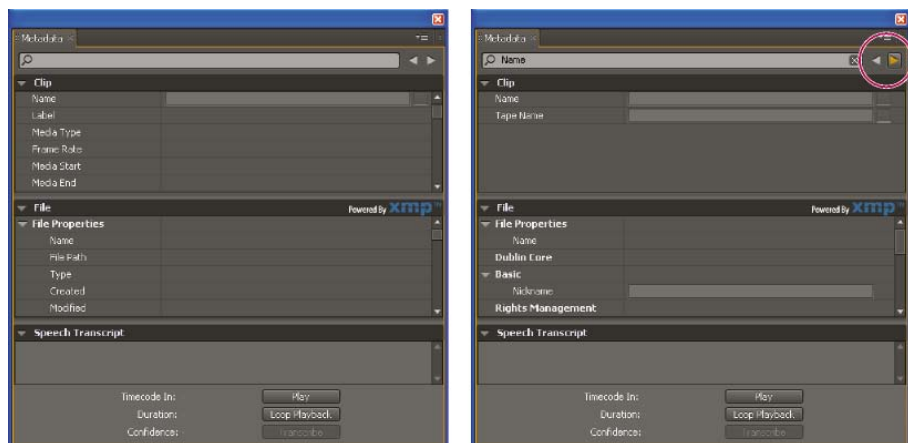

A

B

Metadata panel

A. Before search, all properties appear **B.** After search, only properties with search string appear. In Adobe Premiere Pro, Previous and Next buttons navigate through search results.

Importing assets

[Supported file formats for import](#)

[Advantages of transcoding before or after import](#)

[Import assets and menus](#)

[Importing from Adobe Premiere Pro](#)

[Importing from Adobe After Effects](#)

[Add items or sets to the Library](#)

Supported file formats for import

[To the top](#)

Imported files may require transcoding. DVD- or Blu-ray Disc-compliant assets typically do not require transcoding, while noncompliant assets do.

Supported video file formats

You can import any of the following types of video files:

- AVI (Windows)
- DV-AVI (Mac OS)
- DTS HD

Note: You cannot playback a DTS HD file within Encore or modify the file. In addition, you cannot add this file to motion menus. You can only add the file to a timeline.

This feature is not supported for Flash and DVD projects.

- H.264
- MPEG-2 (including MPG, MPV, and M2V)
- Apple QuickTime® (MOV; including Reference Movies)—requires QuickTime installed on Windows systems
- WMV (Windows Media File)

Video must conform to one of the following frame rates and frame sizes, depending on the TV standard you plan to use for the project.

Frame rates and sizes for standard-definition video formats are as follows.

Standard	NTSC	PAL
Frame rate (frames per second)	29.97 23.976* 23.978* 24*	25
Frame size (pixels)	720 x 480 720 x 486 704 x 480	720 x 576 704 x 576

Frame rates and sizes for high-definition video formats are as follows.

Standard	NTSC	PAL
Frame rate (frames per second)	23.976p 29.97i 59.94p	25i 50p
Frame size (pixels)	720 x 480 1280 x 720 1440 x 1080 1920 x 1080	720 x 576 1280 x 720 1440 x 1080 1920 x 1080

Note: If the high-definition video assets that you import are H.264 encoded, transcode them to 23.976 fps if assets have 24 fps frame rate. Encore cannot burn a Blu-ray project with H.264 assets set to 24 fps.

Supported still-image formats

You can import any of the following types of still-image files:

- Adobe Photoshop (PSD), RGB color space
- Bitmap (BMP)
- GIF
- JPEG
- PICT
- Portable Network Graphics (PNG)
- Targa (TGA)
- TIFF

Note: PSD files must be 8-bit when imported as image assets; when imported as menus they can be 8-bit or 16-bit. TIFF files cannot be imported as menus.

Supported audio file formats

You can import any of the following types of audio files:

- AC3 (Dolby® Digital)
- Audio Interchange File Format (AIF, AIFF; not AIFF-C)
- Digital Theater Sound (DTS)
- mp3
- MPG or M2P (including MPEG-1, MPA, Layer II)
- QuickTime (MOV)
- WAV (32-bit floating-point files are transcoded; 96-kHz 16/24-bit files are not transcoded)
- WMA

Note: DTS audio files will not play during Preview in Encore, even though they will play from the burned disc.

Upper field first support

Encore provides upper field first support for DVDs. If you import a file with an upper field first setting, Encore retains the setting after the import and creates a timeline accordingly. If you transcode this file, Encore maintains the setting in the transcoded file. This feature enhances video quality in Encore.

Advantages of transcoding before or after import

[To the top](#)

A DVD or Blu-ray Disc player can play only video that conforms to certain standards. However, video does not need to be Blu-ray Disc- or DVD-compliant before you import it (though it does need to have the correct frame rate and frame size). Encore includes a transcoding engine that can compress (or transcode) files for DVD or Blu-ray Disc playback. You can transcode video before you import it (in a video-editing application), on import, or when you are ready to build the final project.

Whether you transcode before or after import is up to you. Encore handles both transcoded and untranscoded files equally well.

Transcoding before import

Importing transcoded DVD- or Blu-ray Disc-compliant content allows you to work with the exact assets that will appear on the disc. Also, because the content is already compliant, the time it takes to build the project will be reduced.

Note: In certain instances, Encore needs to transcode DVD- or Blu-ray Disc-compliant files. For example, if the data rate of a DVD-compliant file is too high for the amount of content, the program transcodes the file to bring its data rate down.

Transcoding after import

Allowing Encore to transcode your content gives you more flexibility in placing chapter points (markers within the timeline of the video), inserting subtitles, and trimming your files. The MPEG-2 compression scheme used in transcoding divides the footage into chunks, called a *group of pictures* (GOP). Once transcoded, you can place chapter points and trim only at the header of each GOP, not at specific frames within the group. If you haven't transcoded the file, you are not restricted by GOP headers. In addition, when Encore does transcode the file, it creates GOP

headers at every chapter point you set.

Nontranscoded files also give you more flexibility at build time. In large projects, you often need to adjust the video data rate to fit all the video and audio assets on the DVD. If a file is already transcoded, you might have to transcode it again at a lower data rate, or lower the data rate of the other content to reduce file size.

[To the top](#)

Import assets and menus

Assets can include any combination of the supported content types. You can use video and audio files for your program content or for motion and sound in menus. You can use still images for menu and program content. You can import files stored on your local drive or a network drive.

You can save a step by importing content directly to a timeline, slideshow, or menu. The content must be of the appropriate type to use these shortcuts. While you can import any supported file type as a timeline, you can import only still images as a slideshow and only PSD files as a menu.

For a list of supported file types, see [Supported file formats for import](#).

Import as an asset

1. Make sure that the Project panel is active, and choose File > Import As > Asset.
2. Navigate to the file or files that you want to import, select them, and click Open.

 You can also drag an asset from Microsoft Windows Explorer or the Mac OS Finder into the Project panel.

When you import MPEG 2 files, Encore indexes the MPEG2 files and checks whether the files are DVD legal and Blu-ray legal in the background. Background processing reduces the time to import assets.

It helps quickly release system resources to enable users to resume other activities.

When indexing the MPEG 2 files, Encore displays the files as Pending Media with file names in italics. After indexing completes, Encore updates the status of these files to Completed and displays their names in regular font.

When checking whether the imported MPEG 2 files are Blu-ray legal, Encore displays their status as Pending. At this stage, you cannot transcode these files or burn the project on a blu-ray disc. After checking the files, Encore updates the status of each file to reflect whether it is Blu-ray legal.

When checking whether the imported files are DVD legal, Encore displays their status as Pending. At this stage, you cannot transcode these files or burn the project on a DVD or Blu-ray disc. After checking the files, Encore updates the status of each file to reflect whether it is DVD legal. Encore also updates the group of pictures (GOP) information of the imported file.

Import as a timeline

When you import an asset as a timeline, Encore places both the asset and its timeline in the Project panel. The timeline also appears in the Timeline panel.

1. Choose File > Import As > Timeline.
2. Navigate to the file you want to import, select it, and then click Open.

Import still images as a slideshow

When you import image files as a slideshow, Encore places both the images and the slideshow in the Project panel. The slideshow also appears in the Slideshow panel, where you do a majority of slideshow authoring. For more information, see About slide shows.

Encore creates a single FLV file for a slideshow resulting in seamless playback without any glitch or pauses during slide transition.

1. Choose File > Import As > Slideshow.
2. Navigate to the image files you want to import, select them, and then click Open. You can select multiple, discontinuous files by holding down Ctrl (Windows) or Command (Mac OS) and clicking them.

Import a PSD file as a menu

Menus are an essential element in your project content because they provide the viewer with access to the content contained on the disc. You can customize the templates included with Encore, build menus within the program using your imported assets, or assemble your menus in Photoshop and import them into Encore.

Encore interacts closely with Photoshop. If you follow a specific layer-naming convention for the menus you create in Photoshop, Encore recognizes those layers as specific menu elements, such as buttons and subpictures. Also, because Encore creates all menus as PSD (Photoshop) files, you update your menu in Photoshop, directly from Encore. Photoshop files imported as menus appear both in the Project panel and in the Menus panel and, upon import, automatically open in the Menu Editor.

1. Choose File > Import As > Menu.

2. Navigate to the PSD file or files you want to import, select them, and click Open.

 When dragging the file from Windows Explorer or the Mac OS Finder to the Project tab, Encore imports a PSD file as a menu. However, when holding down Alt (Windows) or Option (Mac OS) as you drag the file, a PSD file is imported as a still image, and not as a menu.

Import a PSD file as a pop-up menu

You can import a PSD file to set it as a Blu-ray pop-up menu. For a pop-up menu, the image background of the PSD file is ignored.

1. On Windows, choose File > Import As > Pop-up Menu. On Mac OS, right-click the Project panel, and select Import As > Pop-up Menu.
2. Navigate to the PSD file or files you want to import, select them, and click Open.

Importing from Adobe Premiere Pro

[To the top](#)

You can import movie files from Adobe Premiere® Pro into Encore through the Adobe Dynamic Link without rendering. When you export from Adobe Premiere Pro using the Adobe Dynamic Link, you can open and edit the original file in Encore. Even though you can import an empty sequence from Adobe Premiere Pro, you cannot create timelines based on these empty sequences. Thus, you cannot link the imported sequence as the motion background for menus that you create.

Movie frames shot using Red cameras can be imported into Encore from Premiere Pro at their full resolution (4K) using Dynamic Link. Encore provides an improved quality of playback for these high-resolution files.

Encore chapter markers in Adobe Premiere Pro (formerly called *DVD markers*) are used to create corresponding chapter points in Encore. If the Name fields for the markers do not contain any text, Encore autogenerates names for the chapter points, such as “Chapter 1,” “Chapter 2,” and so on.

Note: Although DVD markers are not recognized by Encore in files exported from previous versions of Adobe Premiere Pro, files containing numbered markers with text in the Chapter fields are recognized as Encore chapter markers. (Using numbered markers instead of Encore chapter markers in Adobe Premiere Pro is not recommended.)

For an introductory video tutorial about creating DVDs using your Adobe Premiere Pro video files, see www.adobe.com/go/vid0257.

For a video tutorial about using Adobe Dynamic Link between Encore and Adobe Premiere Pro, see www.adobe.com/go/vid0250.

Importing from Adobe After Effects

[To the top](#)

You can import a file from Adobe After Effects®, either as a discrete movie file, or as an Adobe Dynamic Link. The Adobe Dynamic Link option provides the most workflow-friendly import. It lets you import an After Effects composition without rendering it. Using Adobe Dynamic Link, you can switch between Encore and After Effects as needed to update either file until you build the project.

Note: Adobe Dynamic Link is available only if Adobe Creative Suite Production Premium is installed.

If you want to import a discrete movie from After Effects, export an AVI, MPEG, H.264, or MOV file using the Composition > Make Movie command. When the Render Queue panel opens, click the text next to the Output Module heading and select Project Link from the Embed menu. See *After Effects Help* for more information on exporting movie files.

Note: When importing files, Encore can create chapter points from layer-time markers. To import the markers, Encore requires that they contain text in the Chapter field. It names each chapter point using this text. For information on layer-time markers, see *Markers in Adobe After Effects Help*.

For a video tutorial about using Adobe Dynamic Link between Adobe After Effects and Encore, see www.adobe.com/go/vid0250.

Add items or sets to the Library

[To the top](#)

The Library panel contains predesigned templates for menus and other design elements, such as buttons, images, and shapes. If you have still images, logos, buttons, and menus that you use frequently, you can store them in the Library, where you can quickly access them from any project. To keep them organized, you can group them into sets. The Library imports layered Photoshop files, as well as BMP, GIF, JPEG, PNG, and TIFF images.

The Library categorizes items you add based on their content. Menus and buttons require special layer-name prefixes.

Category	File type	File must contain
Menu	PSD, EM	At least one button layer set—layer sets with names that begin with the (+) prefix—and at least one additional layer that

		serves as the background of the menu. Also, any PSD file containing the keyword “menu” in its metadata is categorized as a menu.
Button	PSD	A single layer set with the (+) prefix before its layer name. The layer set may contain subpicture layers and video thumbnail layers. (No background layer.)
Image	PSD, BMP, GIF, JPEG, PNG, TIFF	Image file, or a PSD file not imported as a menu or button.
Replacement Layers	PSD	A single-layer PSD file with a (!) in the name; or a file with a single layer set, with a layer named (!), without the button flag.
Background	PSD	Background layer only.
Layer set	PSD	A single layer set without the button layer-name prefix. (No background layer.)
Text	PSD	A single text layer. (No background layer.)
Vector Shape	PSD	A single vector-shape layer. (No background layer.)

Add an item to the library

Add items and sets to the Library in any of the following ways:

- In the Menu Viewer or the Project panel, select the button, layer, or layer set you want to add, and then drag it to the list of items in the Library.
- In the Project panel, select a still image or menu, and then drag it to the list of items in the Library.
- From Windows Explorer or the Mac OS Finder, drag the item to the Library.
- In the Library, click the New Item button , navigate to the file you want to add, and click Open.

 *Encore uses the letters “HD” in the filenames of predesignated high-definition assets, so they’re easier to locate for Blu-ray projects.*

Create a new Library set

- Choose New Set from the Library panel menu. Type a name for the new set, and click OK.

See also:

- [Video on creating DVDs with Adobe Premiere Pro files](#)
- [Dynamic Link video](#)

 Twitter™ and Facebook posts are not covered under the terms of Creative Commons.

[Legal Notices](#) | [Online Privacy Policy](#)

Transcoding in Encore

[About transcoding](#)

[Transcode settings](#)

[Transcode assets from the Project panel](#)

[Out-of-process transcoding](#)

About transcoding

[To the top](#)

Transcoding is the process by which Encore converts your original, non-DVD-compliant or non-Blu-ray Disc-compliant video and audio asset files to the compliant elements that are burned to the disc. (Files that are already compliant do not require transcoding.) The transcoding feature of Encore is flexible enough for a variety of users. New users unfamiliar with transcoding can let the application manage the process entirely, while those with more experience can control it precisely. If you choose to manage transcoding yourself, Encore provides DVD-compliant and Blu-ray Disc-compliant transcode presets customized for several different quality and storage requirements. You can also create your own custom transcode presets.

You can work with your original, untranscoded files throughout the production process; Encore performs any required transcoding when you build the final project. If you want more control over transcoding, however, you can choose to transcode at any time on a per-item basis. If a transcoded version of a file is available, Encore uses that version for authoring, previewing, and building; if no transcoded version is available, the application uses the original file for authoring and previewing, and transcodes the files as necessary when building.

Transcode settings

[To the top](#)

You can specify an item's transcode settings (by using a preset) from the DVD Transcode Settings or Blu-ray Transcode Settings columns in the Project panel. (Separate columns, DVD Transcode Status, and Blu-ray Transcode Status, display either Transcoded or Untranscoded to show the item's current state.) When you specify a preset, that preset's data rate is used, not the data rate you calculated in bit budgeting.

Assets are designated as follows in the DVD Transcode Settings and Blu-ray Transcode Settings columns:

Automatic Displayed for all non-DVD-compliant or non-Blu-ray Disc-compliant assets by default.

For assets with the Automatic designation, Encore determines the optimal settings for transcoding. Encore bases these settings on the number, length, and size of the assets and the available disc space. (See [About bit budgeting](#).) You can override the Automatic data rate setting by specifying the Maximum Audio/Video Bitrate on the Advanced tab of the Project Settings dialog box. Alternatively, you can specify a transcode preset for any of these assets.

Important: *Set the encoding profile as Main for your H.264 video assets in your Blu-ray projects. You cannot burn a Blu-ray Disc if you set the encoding profile as High. See [Preset options for video](#)*

[A transcode preset name] Displayed for all non-DVD-compliant or non-Blu-ray Disc-compliant assets for which you have specified a Project Transcode Preset.

Don't Transcode Displayed for those assets that are already DVD-compliant or Blu-ray Disc-compliant. You can override this setting and specify Automatic or a transcode preset, if desired.

Note: *DVD/Blu-ray Disc-compliant, audio-only files that don't match the audio encoding preference are the exception; Encore assigns these audio files a designation of Automatic. You can override this setting and specify either Don't Transcode or a transcode preset. (Dolby® Digital 5.1 AC3 files retain the Don't Transcode designation for quality purposes; this designation can also be overridden to transcode to Dolby® Stereo format.)*

N/A Displayed for those items, such as menus and timelines, that don't require transcoding.

Transcode assets from the Project panel

[To the top](#)

You can assign transcode settings and transcode individual assets directly from the Project panel. Upon transcoding a file, Encore updates the project link so that it points to the transcoded file. Consequently, unless you delete the original file, you can revert transcoded assets to their original version. Encore transcodes in the background, so you can continue to work while transcoding.

Note: *If Encore is transcoding an asset in the background, you cannot delete timelines associated with the asset or assign a different preset.*

The data rate calculated for the Automatic transcode setting, determined by Encore, appears in the Bitrate column in the Project panel. You can specify the maximum automatic data rate using the Advanced tab in the Project Settings dialog box.

Assign a transcode setting to an asset

1. In the Project panel, right-click (Windows) or Control-click (Mac OS) the asset you want to transcode, and choose Transcode Settings.

2. In the Transcode Settings dialog box, choose a transcode preset from one of the Quality Preset menus for DVD Transcoding or Blu-ray Transcoding, and then click OK. (For information on editing the presets, see About project transcode presets.)

Override the Automatic data rate setting

❖ To specify the maximum audio/video transcoding bit rate that Encore uses automatically, choose File > Project Settings, click the Advanced tab, choose the data rate limit from the Maximum Audio/Video Bitrate menu, and then click OK.

Transcode an asset

1. In the Project panel, right-click (Windows) or Control-click (Mac OS) the asset you want to transcode.
2. Choose Transcode Now. The asset is transcoded, and the Transcode Status column displays Transcoded. The transcoded asset is now used for authoring, previewing, and building.

Revert a transcoded asset to the original asset

1. In the Project panel, right-click (Windows) or Control-click (Mac OS) the asset you want to replace.
2. Choose Revert To Original.

Out-of-process transcoding

[To the top](#)

Out of process transcoding enables you to transcode assets in the Adobe Media Encoder application in the Transcode Now workflow. When you enable out-of-process transcoding, the Adobe Media Encoder (AME) is launched as a separate process.

Out-of-process transcoding runs independent of the Encore process. The memory in the Encore process is not consumed when transcoding.

Note: *Out of process transcoding option is used only in the Transcode Now workflow, and not in the Build workflow.*

Out-of-process transcoding is disabled by default. To enable out-of-process transcoding, perform the following steps.

1. Select Edit > Preferences > General.
2. Select Transcode Assets Using Adobe Media Encoder Application.

More Help topics



[Legal Notices](#) | [Online Privacy Policy](#)

Transcoding presets

- [About project transcode presets](#)
- [Preset options for video](#)
- [Preset options for audio](#)
- [View a preset's parameters](#)
- [Create a custom preset](#)
- [Export and import presets](#)
- [Delete custom presets](#)
- [Specify a pre- or post-encoding task](#)

About project transcode presets

[To the top](#)

You work with presets in the Export Settings dialog box. (To open it, choose File > Edit Quality Presets.) The left portion of the dialog box displays either the source or the output, while the right portion lists the various settings available. Use the Source tab to see the original, and use the Output tab to preview the effects of your selections.

The default parameters in the Project Transcode Presets dialog box are designed to achieve optimal quality for various project types. You can save, import, export, and delete presets.

If you are experienced with MPEG-2 or H.264 encoding, you can further fine-tune your projects for specific playback situations by creating custom presets. You create a custom preset by adjusting the video and audio parameters of any of the existing presets. Once you save this custom preset, you can use it in later projects or share it with other users.

Note: All available transcode presets are based on the project settings. For example, if you choose PAL project settings, then only PAL-compatible presets are available.

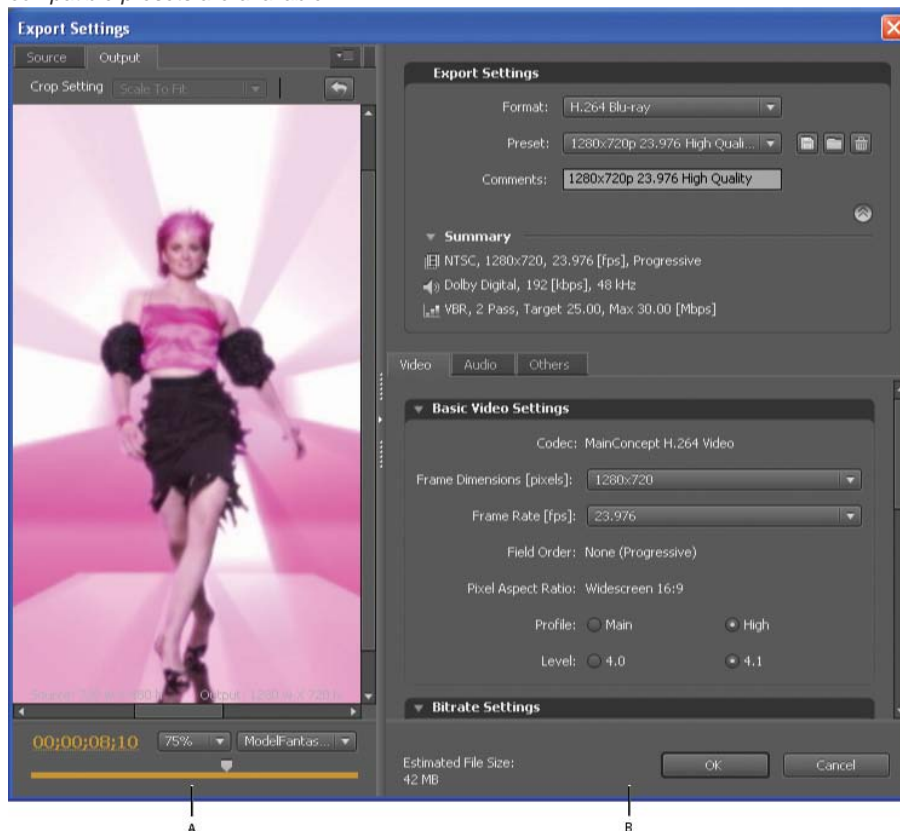

Project Transcode Presets dialog box

A. Source or output image B. Preset settings

Preset options for video

[To the top](#)

Depending on the preset you've selected, the Video tab of the Project Transcode Presets dialog box contains some or all of the following options:

Codec Displays the codec based on the export format you specified.

Frame Dimensions [Pixels] Specifies the frame dimension of the video.

Frame Rate [fps] Specifies the frame rate in frames per second.

Quality Specifies the encoding quality. Quality values range from 1 to 5, with higher values increasing quality and render time.

Note: *H.264 does not have settings for Quality, M frames, or N frames.*

Field Order Specifies which field of a frame occurs first. Use the same settings as the source. Only appears if you select Interlaced as the Program Sequence option.

Pixel Aspect Ratio Specifies the pixel aspect ratio. See Specify an asset's pixel aspect ratio.

Profile Specifies the encoding profile for generating the video stream. Applicable for H.264 encoding only.

Note: *For Blu-ray projects, the encoding profile must be Main when you select H.264 as the encoding format. You cannot burn a Blu-ray disc when the encoding profile for a H.264 video asset is set to High.*

Bitrate Encoding Specifies the compression technique used. Constant Bit Rate (CBR) compresses data to a fixed rate. CBR keeps the rate constant by varying the amount of compression (and thereby quality) as required by the specified data rate. Variable bit rate (VBR) compresses data to fit between a fixed minimum and fixed maximum rate. VBR allows the compression to vary, which can result in better quality than CBR.

Bitrate [Mbps] Specifies the number of Mbps you want the encoded file to have. Only appears if you select CBR as the Bitrate Encoding option. The following options appear only if you select VBR as the Bitrate Encoding option:

Encoding Passes Specifies the number of times the encoder analyzes the clip before encoding. Enabled for VBR only.

Target Bitrate [Mbps] Specifies the number of Mbps you want the encoded file to have. For VBR, the target provides an average bit rate. (See [Calculate a bit budget.](#))

Maximum Bitrate [Mbps] Used with VBR only. Specifies the maximum number of Mbps you want the encoder to allow. The maximum allowable rate is 40.0 Mbps for Blu-ray Disc assets and 9.0 Mbps for DVD assets, providing a safety margin.

Minimum Bitrate [Mbps] Used with VBR only. Specifies the minimum number of Mbps you want the encoder to allow. The minimum bit rate must be at least 0.192 Mbps for Blu-ray Disc assets and 1.5 Mbps for DVD assets.

M frames Specifies the number of B frames between consecutive I and P frames.

N frames Specifies the number of frames between I frames. This value must be a multiple of the M frames value.

Preset options for audio

[To the top](#)

The Audio tab of the Export Settings dialog box contains the following options, depending on the codec chosen:

Audio format Specifies the codec the encoder uses to compress the audio:

Note: *NTSC discs must contain either PCM Audio or Dolby® Digital; they cannot contain only MPEG audio. This restriction does not apply to PAL discs.*

- Dolby® Digital is a high-quality encoding format developed for multichannel digital sound and the most common encoder for DVD-video. Encore encodes Dolby® Digital 2.0 (stereo) audio files.
- MainConcept MPEG Audio uses MPEG-1 Layer II audio in stereo.
- PCM (Pulse-Code Modulation) Audio is a lossless audio format sampled at 48 kHz in Encore. Files of this format tend to be large, occupying more disc space than the other encoder formats.

Note: *MPEG Audio is not available for Blu-ray MPEG-2 or H.264.*

Codec Specifies the codec for encoding the clip's audio.

Audio Layer Specifies the audio layer used for encoding.

Frequency Specifies the audio sample rate in kHz.

Bitrate [Kbps] Specifies the output bit rate of the audio. This option is only available for Dolby® Digital and MainConcept MPEG Audio codecs.

View a preset's parameters

[To the top](#)

1. Choose File > Edit Quality Presets.
2. In the Export Settings section, choose a preset from the Preset menu and view its properties listed under Summary. Click OK to close the dialog box.

Note: *The estimated file size per second is displayed at the bottom of the dialog box. If you change a preset's parameter that affects file size, such as target bit rate, the estimate updates to reflect your change.*

Create a custom preset

[To the top](#)

1. Choose File > Edit Quality Presets.
2. In the Export Settings section, choose MPEG2 Blu-ray, MPEG2 DVD, or H.264 Blu-ray from the Format menu, and choose the preset you want to edit from the Preset menu.
3. If applicable, type a comment in the Comment box.

4. Click either the Audio or Video tab and adjust an option as desired. (See Preset options for video and Preset options for audio.)
5. When you finish adjusting the options, click the Save Preset button .
6. Type a name for your preset, and click OK.
Your new preset appears in the Presets menu in the Export Settings dialog box.
7. Click OK to close the Project Transcode Presets dialog box.

Export and import presets

[To the top](#)

After you fine-tune a preset for a project, you can export it for use in other projects.

Export a preset

1. Choose File > Edit Quality Presets.
2. In the Export Settings section, choose the preset you want to export from the Presets menu.
3. Alt-click (Windows) or Option-click (Mac OS) the Save Preset button  to display the Export Preset dialog box.
4. Choose the location to save the preset, name it, and then click Save.

Import a preset

1. Choose File > Edit Quality Presets.
2. In the Export Settings section, click the Import Preset button  to open the Import Preset dialog box.
3. Navigate to the location of the preset, select it, and then click Open.
4. Enter a name for the imported preset, and then click Open.

Delete custom presets

[To the top](#)

1. Choose File > Edit Quality Presets.
2. In the Export Settings section, do one of the following:
 - To delete a single preset, choose the preset you want to delete from the Preset menu, and then click the Delete Preset button . Click OK to confirm the deletion.
 - To delete all custom presets, Ctrl-Alt-click (Windows) or Command-Option-click (Mac OS) the Delete Preset button. Click Yes to confirm the deletion.

Specify a pre- or post-encoding task

[To the top](#)

Included with the transcode presets are pre- and post-encoding tasks. You can use these tasks to make changes to the asset either before or after it's transcoded. You can specify that a text log of errors, warnings, and settings be saved with the transcoded file. When you add encoding tasks to a preset, you generate a custom preset.

1. Choose File > Edit Quality Presets.
2. Select the transcode preset you want to add a task to.
3. To add the post-encoding task of logging, click the Others tab and select the Log File Details checkbox. Then select the details you want logged.
4. Click OK.
5. In the Choose Name dialog box, enter a name for the custom preset, select Save Filter Settings and/or Save Other Tasks, and click OK.

More Help topics



[Legal Notices](#) | [Online Privacy Policy](#)

Transcript metadata in Flash output

Adobe Premiere Pro and Soundbooth let you convert spoken words into text transcripts, which you edit and search just like other metadata properties. This powerful technology lets you navigate to time locations at which specific words are spoken, helping you better align edits, advertising, and subtitles.

When you import assets from Premiere Pro, metadata including the speech transcripts that you created for these assets is imported. The transcript metadata is embedded chapter-wise in your Flash output when you export the project to Flash. You can search the Flash files for specific words and locate the scene in which the speech occurs.

In addition, you can use Adobe® Bridge® to search for and access your project files, preview and apply settings, run batch processes, and tag assets with XMP metadata panel in Encore.

Because the videos that you upload to websites contain searchable metadata, search engines such as Google can locate and present the videos that contain the specified search term.



[Legal Notices](#) | [Online Privacy Policy](#)

Menus

Menu basics

About menus

Button subpicture states

Menu Viewer overview

The Library panel

Layers panel overview

Use guides to position menu items

Name menus and buttons

Specify the default button for a menu

Menus contain navigation buttons that give viewers access to the contents. Menu buttons can play a movie or individual chapter, jump to other menus, set active audio and subtitle tracks, or play back special features. Menus can range from a single button on a plain background to a flashy screen with moving images and buttons that change as you select them.

Encore provides you multiple options to create and edit menus. You can create simple, basic menus with predesigned assets in Adobe® Encore® or edit them in Adobe Photoshop®. Further, you can add audio and video to your menus and advanced animations using Adobe After Effects®.

Encore uses the Photoshop file format for menus, providing you complete control in creating and enhancing your menus in Encore, Photoshop, or After Effects. For example, you can start with a basic menu based on a predefined asset from Encore and edit it in Photoshop to fine-tune the designs. You can then take it to After Effects to add animations of your choice, and then import into Encore as the final menu. In the entire workflow, Encore treats the menu that you are creating as a PSD file. For a video tutorial about working with menus, see www.adobe.com/go/!rvid4228_enc.

About menus

[To the top](#)

The main menu in an Adobe® Encore® project is usually the first screen the viewer sees. Depending upon the complexity of the contents, your project can contain a single menu or multiple menus. Many projects require that buttons on the main menu link to additional menus, called submenus. For example, a main menu can have buttons to play the entire movie, select chapters, and set audio and subtitle options.



Main menus and submenus give viewers access to contents.

You can have your project display other types of menus (or video, for that matter) before leading to the main menu. For example, the startup screen can have a single-button welcome menu or a multi-button menu to choose the appropriate language.

Parts of a menu

A menu consists of a background, buttons, and button subpictures. Button subpictures change the appearance of buttons when the viewer selects or activates the button with the remote control or mouse. (See Button subpicture states.)



A. Buttons lead to content **B.** Subpicture highlights button when selected or activated **C.** Background

Types of menus

A menu can include text, still images, motion footage, and audio. Depending on its composition, a menu is considered either a still menu or a motion menu:

Still menu A menu composed of static images. It contains no moving footage or audio.

Motion menu A menu that includes moving footage or audio. A video can play in the background of the menu. Menu buttons can include thumbnail versions of the movies to which they're linked. You can even include audio, such as music or narration, while the menu is displayed.



Buttons display thumbnail versions of linked video.

Blu-ray pop-up menu A “button over video” menu that is available only for the Blu-ray Disc. Blu-ray pop-up menus can be associated with one or more timelines. See Blu-ray pop-up menus.

Button subpicture states

[To the top](#)

Button subpictures let you change the look of buttons in response to the remote control or mouse. Each button has three possible states:

Normal Displayed when the button is not selected by the remote control or mouse.

Selected Triggered when the viewer navigates to the button with the remote control or mouse. When a menu opens, one button is always preselected.

Activated Triggered when the viewer presses Enter on the remote control after navigating to the button or when the viewer clicks the button with the mouse. Depending upon the player that the viewer is using, the display time of the activated state can be very short, so designers often make the selected and activated state the same.

The Adobe predesigned menus and buttons include subpictures. You can let Encore create subpictures for you by using the Create Subpicture command or the Convert To Button command. You can design your own subpictures in Adobe Photoshop. (See About creating menus in Photoshop.)

Menu Viewer overview

[To the top](#)

The Menu Viewer provides a canvas for creating and modifying a menu. You can place, move, resize, flip, rotate, or delete buttons, and you can add text. When creating and editing a menu in the Menu Viewer, you frequently use other panels. For example, you can use the Project panel to drag and drop video clips, audio clips, and images onto a menu. You can use the Library panel to add content, including predesigned templates and buttons, to your menu. You use the Layers panel to view, navigate, and edit the layer structure of a menu. Use the Properties panel to change motion and navigation options for either menus or menu buttons.

 You can display the Menu Viewer on an attached DV device (IEEE 1394). In the Audio/Video Out panel of the Preferences dialog box, select the Show Menu Editor On DV Hardware option.

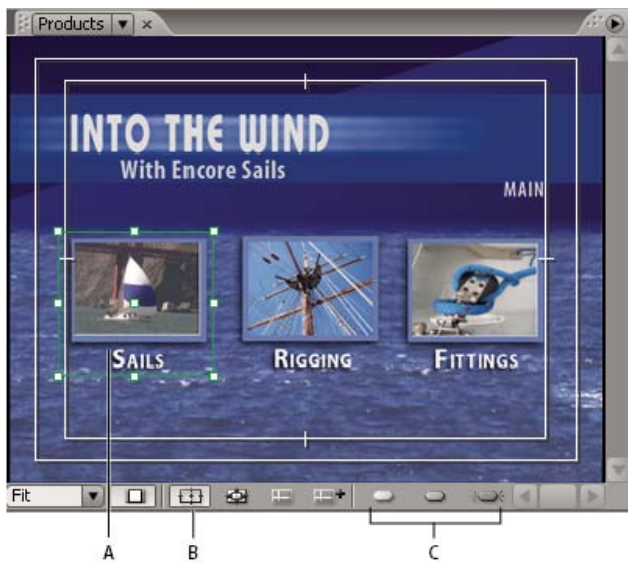

Menu Viewer

A. Selected object **B.** Show Safe Area **C.** Subpicture display buttons

The Menu Viewer contains the following controls:

Zoom Level Controls the magnification of the menu. Choose a preset zoom level, or type a value from 25% to 1600% and press Enter. You can also choose Fit to view the entire menu, even if you resize the Menu Viewer.

Note: You can also press the + (plus) key to zoom in and the - (minus) key to zoom out. For more keyboard shortcuts, see [Using keyboard shortcuts](#).

Correct Menu Pixels For TV Display Toggles between displaying the menu as it will appear on a television monitor (default setting) and displaying the menu's true dimensions and uncorrected pixel aspect ratio (if different from the project frame size).

Show Safe Area Displays guides that mark the action safe areas and title safe areas. Television monitors reduce the visible area of footage and menus. You should keep important visual elements within the outer guide, and keep text and buttons within the inner guide. (The actual amount that is clipped varies from monitor to monitor.)

Show Button Routing Displays remote control routing and button numbers of all buttons in the menu. You can customize the routing only if the Automatically Route Buttons menu property is turned off. (See Change the routing order.)

Show Guides Displays any guides you added to the menu for aligning buttons and objects.

New Guide Displays the New Guide dialog box, where you can specify the type of guide (horizontal or vertical) you want to add and its position in pixels coordinates within the menu. Guides are saved with the menu and can be viewed in Photoshop.

Show Normal Subpicture Highlight Displays the normal (unselected) state of all buttons.

Show Selected Subpicture Highlight Displays the selected (highlighted) state of all buttons.

Show Activated Subpicture Highlight Displays the activated state of all buttons.

To improve performance, turn off the display of subpictures when they're not needed.

In addition, Encore has added a special feature in the Menu Viewer to highlight any buttons that overlap each other with a bright red outline, making it easier to avoid potential linking problems.

The Library panel

[To the top](#)

Library panel overview

The Library panel includes predesigned menus that represent a wide spectrum of visual styles and themes, such as Education, Corporate, or Wedding. You can create menus based on these predesigned templates or customize menus using other design elements, such as buttons, images, and shapes. You can create menu templates and add your own design elements to the Library panel so that menus and designs that you use frequently are right at hand.

Many menus have a companion submenu that reflects the same style and contains a different number of buttons. The menus include buttons with subpictures (for highlighting when the button is selected) and fully styled placeholders for text. The buttons on some menus provide a thumbnail layer for video.

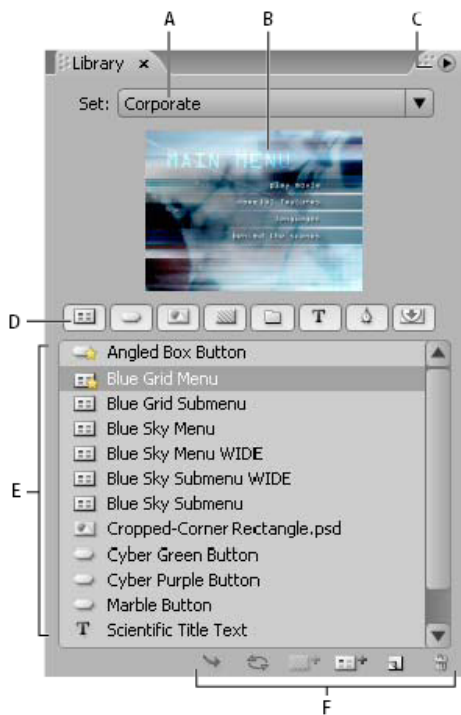







Library panel

A. Name of currently displayed set **B.** Preview of selected item **C.** Panel menu with additional options **D.** Buttons to display different types of items **E.** Predesigned items **F.** Buttons to place, replace, add, and remove items

The Library panel contains the following controls:

Set Displays the currently selected set. Items in the Library panel are organized into thematic sets, such as Education, Corporate, or Wedding. You can create your own sets or add to the existing sets.

Panel menu Contains commands to add or delete items or sets and to rename existing sets. It also includes commands for undocking and closing the panel or the frame containing the panel.

Category buttons Display predesigned items of a specific type: Menus , Buttons , Images , Backgrounds , Layer Sets , Text Items **T**, Shapes , and Replacement Layers . Shift-click to view additional categories. Alt-click (Windows) or Option-click (Mac OS) to view all categories together.

Place  Places the selected item in the currently displayed menu. Buttons are added on the left edge of the title safe guide without overlapping previously placed buttons. Images, shapes, and layer sets are centered in the middle of the menu.

Replace  Replaces the objects selected in the menu with the item selected in the Library panel. The Replace button resizes the Library panel item to fit the dimensions of the object in the menu. You can also use the Replace button to replace a menu with another menu while preserving links and text. (See Replace a menu with another menu.)

Set Background  Replaces the background layer of the currently active menu. This option is enabled only if a background is selected in the Library panel.

New Menu  Creates a new menu using the selected menu or background.

New Item  Opens a dialog box to let you select a file. Once selected, adds the item to the Library panel and copies the item to the Library set folder.

Delete Item  Removes the selected item from the panel. You can delete only items you've created.

Set Library panel default menus and buttons

Each thematic set in the Library panel has a default menu, background, and button that Encore uses when you create a new menu or button. You can specify the defaults for each set. You can also add your own menu or button to the panel (using the panel's New Item button) and set it as a default. A star in the icon adjacent to a button, background, or menu name identifies it as the default for the set.

Encore uses these defaults of the currently selected set to create a new menu or button whenever you choose the Menu > New Menu command, click the Create A New Item button in the Project panel and choose Menu, or drag an asset from the Project panel directly to a menu in the Menu Viewer.

Set a default menu in the Library panel

❖ In the Library panel, right-click (Windows) or Control-click (Mac OS) the menu template or background that you want to be the default menu, and choose Set As Default Menu.

Set a default button in the Library panel

❖ In the Library panel, right-click (Windows) or Control-click (Mac OS) the button that you want to be the default, and choose Set As Default Button.

Layers panel overview

Encore uses the Photoshop® file structure for creating menus. The Layers panel in Encore displays the contents of the Photoshop file that is used as the basis for the menu. Therefore, you can edit menus in either program without losing the layer organization. The Layers panel is especially useful when working on multilayered menus, such as menu templates.

Each object you add to a menu appears on a separate layer in the Layers panel. Selecting objects in the Menu Viewer is sometimes easier when you use the Layers panel. Regardless of where an object is in the stacking order, you can quickly select it by selecting its layer in the Layers panel. When you select a layer or layer set, selection handles appear on the element in the Menu Viewer. You can isolate elements to change them together or individually, view only specific layers while hiding others, and lock layers or layer sets so that their elements cannot be modified. The Layers panel is especially useful when working on menus with a lot of layers, such as menu templates.

 You can design entire menu templates in Photoshop, import them into your Encore projects, and save them in the Library panel for reuse.

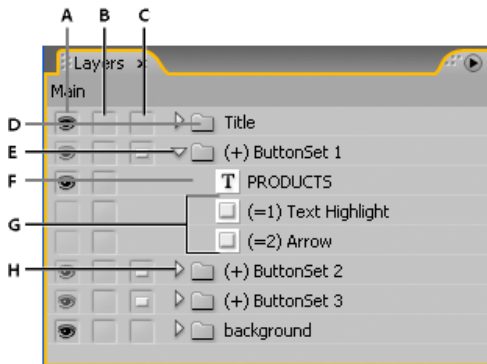





Layers panel

A. Display/Hide column **B.** Lock/Unlock column **C.** Button/Object column **D.** Layer set **E.** Button layer set **F.** Text layer **G.** Subpicture layers **H.** Open/Close layer set

The three columns adjacent to the layers let you selectively hide, display, or lock the contents of layers and layer sets, as well as convert objects to buttons and convert button sets to individual elements. Clicking the column next to a layer turns the option on or off.

Display/Hide column Hides or displays the layer in the Menu Viewer. The Eye icon  next to a layer indicates that it is visible. Hiding layers lets you work on a layer in isolation and makes it easier to adjust a layer that is behind other objects.

Note: You cannot hide button layer sets, only the elements within them. You also cannot use the Display/Hide column on subpicture layers—layers with names that begin with (=1), (=2), or (=3). To hide or display subpicture layers, you use the Show Normal Subpicture Highlight button , Show Selected Subpicture Highlight button , and Show Activated Subpicture Highlight button  in the Menu Viewer. (See Button subpicture states.)

Lock/Unlock column Locks or unlocks a layer in the Menu Viewer so that it can't be selected, moved, or modified. Locking layers or layer sets protects the elements from accidental changes. The Lock icon  indicates that it is locked.

Button/Object column Converts the layer to a button or back to an object. The Button icon  indicates that the layer is a button. Converting an object to a button creates a new button layer set with a plus-sign prefix (+) added to its name. Converting a button set to an object removes the prefix from the layer set name, but leaves the button elements grouped in a layer set.

Use guides to position menu items

Guides help you position items in menus. You can add, move, remove, or lock guides, and turn them on or off. Guides are visible only in the Menu Viewer. You do not see them when previewing or in the final product. Guides have an optional setting that makes objects you drag snap to them. The selection boundary and the center point of objects, as well as the baseline of type, snap to the guides.

You place guides at pixel locations in the menu, the zero point being the upper-left corner of the menu.

The guides you create are specific to that menu. They are saved in the menu and transfer with a menu between Encore and Photoshop. Any changes you make to the guides in either program transfer with the menu.

Note: When setting guides to align objects in several menus, it is important to remember that you place guides at the pixel location of the menu, not the screen. Therefore, if you have menus created using square pixels in the same project as menus using rectangular pixels, guides placed at the same pixel location in each menu can result in different locations on the screen. For example, horizontal guides placed at 75 pixel do not line up between a 720 x 534-pixel menu (square pixels) and a 720 x 480-pixel menu (rectangular pixels).

Add a guide

1. Open the menu to which you want to add guides.
2. Choose View > New Guide or click the New Guide button  at the bottom of the Menu viewer.
3. Select Horizontal Guide or Vertical Guide orientation, enter a position, and click OK.

Move a guide

❖ Using a selection tool, position the pointer over the guide. When the pointer turns into a double-headed arrow, move the guide.

Remove guides

- To delete a single guide, using a selection tool, drag the guide completely outside the Menu Viewer.
- To remove all guides, choose View > Clear Guides.

Set snap-to or lock guides

❖ Do one of the following:

- To set snap-to guides on or off, choose View > Snap To Guides.
- To lock guides, choose View > Lock Guides.

Show or hide guides

❖ Do one of the following:

- Choose View > Show Guides.
- Click the Show Guides button  at the bottom of the Menu Viewer.

[To the top](#)

Name menus and buttons

To make menus and buttons easier to identify, you can change their default names in the Properties panel.

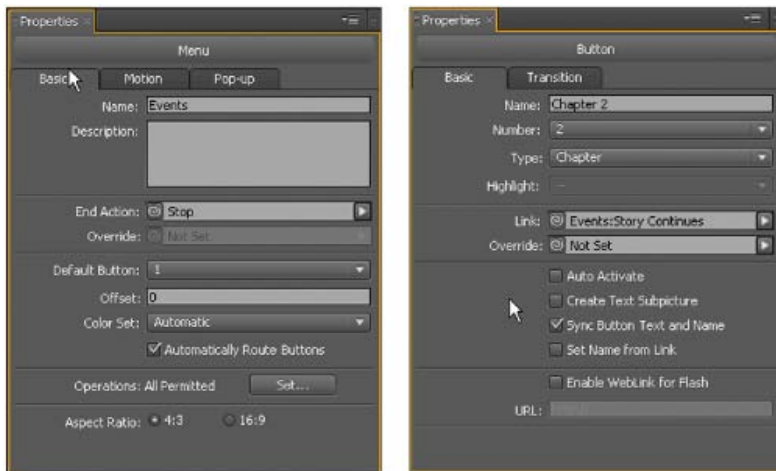

Properties panel for selected menu (left) and selected button (right)

Name and describe menus

Names and descriptions of menus can help keep your project organized. In addition, you can use the Description field to add special notes or to embed web links in a Flash project. (See [Embed web links in your Flash project.](#))

1. Select the menu in the Project panel or Menu panel.
2. In the Properties panel, select the current name and type a new name.
3. In the Description box, type any notes about the menu.

 To rename a menu or button, you can also right-click (Windows) or Control-click (Mac OS) it and choose *Rename*. Type the new name in the dialog box, and click *OK*.

Name a menu button

By default, button names match the text on the buttons. If you change one, the other updates automatically. You can unlink the button name from the button text and name the button independently. You can also set a button name to match the name of the element that the button is linked to.

1. In the Menu Viewer, select the button.
2. On the Basic tab of the Properties panel, do one of the following:
 - To rename the button without affecting the text on the button in the menu, deselect *Sync Button Text And Name* and type a name in the Name box.
 - To match the button name with the name of the element linked to, deselect *Sync Button Text And Name*, and select *Set*

Name From Link.

- To match the button name and button text, select Sync Button Text And Name, and deselect Set Name From Link.

Sync Button Text And Name is selected by default and affects only the topmost text layer in the button layer set. Set Name From Link is deselected by default.



Choose Edit > Preferences > Menus (Windows) or Encore > Preferences > Menus (Mac OS) to change the default settings of the Set Name From Link and Sync Button Text And Name options.

- To add a web link to the Flash output, select Enable Weblink For Flash, and then enter the URL for the link.

Specify the default button for a menu

[To the top](#)

Each time a menu appears, one button appears highlighted (selected) for the viewer. By default, this is button number 1. When a link leads to a menu, it may designate that a different button appear highlighted. That link setting replaces the default button only for that viewing of the menu.

Note: *Default menu button settings are ignored in Flash projects.*

1. Select the menu in the Project panel or Menu panel.
2. In the Properties panel, from the Default Button menu, select the number of the button that you want to be the highlighted button by default. (For information on assigning different numbers to the buttons in the menu, see [Rename buttons](#).)



For menus that let the viewer select audio and subtitle tracks, you can choose to highlight the active track's button, as a point of reference for the viewer. Choose Active Audio Track or Active Subtitle Track from the Default Button menu.

More Help topics

[About button subpictures](#)



[Legal Notices](#) | [Online Privacy Policy](#)

Button subpictures

- [About button subpictures](#)
- [Create automatic button subpictures](#)
- [Paste an image as a subpicture](#)
- [Update subpicture text automatically](#)
- [Create subpictures in Photosh](#)
- [View subpictures](#)

About button subpictures

[To the top](#)

A DVD or Blu-ray Disc player uses *button subpictures* to highlight buttons. A button subpicture defines the appearance of a button when it's selected, activated, or in its normal (unselected) state. All the predesigned buttons included with Encore come with button subpictures. Encore can create subpictures for a button and update the text in the button subpictures automatically any time you change the text on the button. For full control over the design of button subpictures, you can create them in Photoshop. (See [Create subpictures in Photoshop.](#))

You can create button subpictures from predesigned buttons in the Library panel, the Object > Create Subpicture command, or by designing new in Photoshop. Regardless of how you create your button subpictures, you set the colors used for button subpictures in the Color Set dialog box.

Create automatic button subpictures

[To the top](#)

The easiest way to create a button subpicture is to use the Object > Create Subpicture command. This command creates a single-color image of the button. It bases the shape of the created subpicture on the text and image layers that are set as visible within the button layer set. Before you use the command, you can hide layers in the button set using the Layers panel. You can then control which elements Encore uses to create the button subpictures.

The colors displayed for each button state come from the color definitions in the color set, not from the button itself. By default, Encore uses the Automatic color set, which is based on the colors of the subpicture layers of the button. You can design more complex, three-color button subpictures in Photoshop. (See [Create subpictures in Photoshop.](#))

Note: *The predefined menus and buttons in the Library panel include button subpictures.*

1. Open the menu. In the Menu Viewer, select a button.
2. If you want to create button subpictures based only on certain layers, use the Layers panel to hide the button layers you don't want used.
3. Choose Object > Create Subpicture.
4. In the Properties panel, select a color group from the Highlight pop-up menu.

Encore assigns the selected Color Group to the button.

Note: *If the Highlight pop-up menu is dimmed, the menu is using the Automatic color set.*

Paste an image as a subpicture

[To the top](#)

The Paste As Subpicture command lets you quickly create a single-color subpicture from a layer in the menu.

Encore supports 8-bit color in subpictures for Blu-ray disc menus. You can export 256-color menu subpictures for Blu-ray. In addition, you can export full original colors for menu button highlights in Flash.

To export subpictures in full original colors, select Export Highlights in Rich Color in the Menu Properties pane. Encore displays menu highlights with full colors in Menu Editor.

However, Encore only displays two-bit DVD colors in the Preview panel. If you do not enable this feature, Encore exports menu highlights in two-bit colors for Blu-ray and Flash.

Encore also lets you import colors for various states of button highlights for blu-ray and web DVD. You can use numeric prefixes to distinguish states, such as normal, selected, and activated and import colors individually for these states. For example, use (=1)prefix for the normal state. Use (=2)prefix for the selected state and (=3)prefix for the activated state.

 *You can create invisible buttons by using the Paste As Subpicture command in a layer without any buttons selected.*

1. Open the menu.
2. In the Layers panel, select the layer you want to use as a subpicture, and choose Edit > Copy.
3. Select the button layer set into which you want to paste the new subpicture.
4. Choose Edit > Paste As Subpicture.

The image is pasted into the button layer set and is given the subpicture prefix (=1).

5. In the Properties panel, select the desired color group from the Highlight pop-up menu.

Encore assigns the selected Color Group to the button.

Note: If the Highlight option is dimmed in the Properties panel, the menu is using the Automatic color set.

Update subpicture text automatically

[To the top](#)

The button property Create Text Subpicture can automatically generate a subpicture for button text. Any time you change the text, it regenerates the subpicture for you—you don't have to manually update the subpicture layers. This option is very useful as you develop the menus in a project or if you create menus to be customized by others.

1. In the Menus panel, select the menu containing the buttons with subpicture text.
2. In the lower section of the panel, select all the buttons that you want updated automatically.
3. In the Properties panel, select Create Text Subpicture.

Create subpictures in Photosho

[To the top](#)

Subpictures can be difficult to understand, especially if you are accustomed to creating rollovers for web pages. Although on the surface subpictures and web-page rollovers appear alike—they both indicate button status—the DVD requirements make subpictures very different.

The first concepts you need to understand are as follows:

- The subpicture is like a transparent overlay that sits on top of the menu.
- The DVD or Blu-ray Disc player uses the same overlay for all three button states. (Even the normal state uses the same subpicture.)
- The *color set*, not the colors in your original image, ultimately control the colors displayed in the subpicture. (Technically, the subpicture overlay is a two-bit indexed image.)
- The subpicture is limited to three colors (each represented by a layer in the button set), but you can change those three colors and their visibility for each state in the color set. (DVD regulations allow only a limited bandwidth for button subpictures and subtitles.)

Think of the subpicture as a paint-by-number image, with areas designated for colors 1, 2, or 3. The color set is the color key that determines what colors (if any) are used for colors 1, 2, and 3. In addition, all three colors can have different definitions and opacity settings in each button state. By varying the color definitions for each state, you can change the colors of each area; by varying the opacity of the colors in each state, you control whether or not that area is even visible in a particular state.

You build the image used for the subpicture by creating separate layers for each color. The layer names must include the following prefixes: (=1) for areas using color 1, (=2) for areas using color 2, and (=3) for areas using color 3.

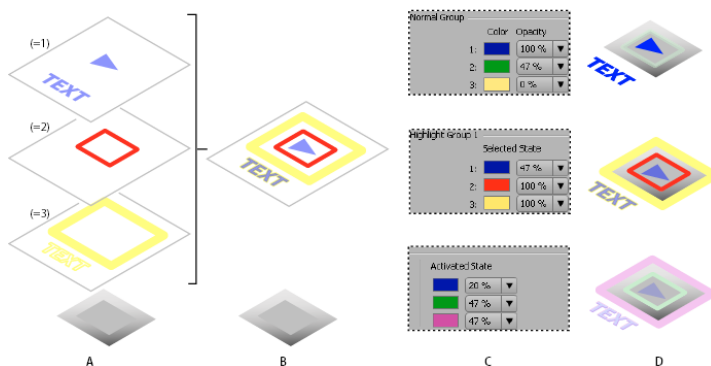

Relationship between subpicture layers in button set and color set definitions

Guidelines for creating subpictures

Keep in mind the following guidelines as you create the subpicture layers:

Same overlay used for all states The same image or overlay is used for all three states of a button (normal, selected, and activated).

Layers flattened into single overlay The subpicture layers you create are flattened into a single image in the build process.

Top layer wins If subpicture layers in a button layer set overlap, the top layer takes precedence when the layers are flattened into the final overlay.

Layers part of button layer set The subpicture layers for a button must be contained within that button's layer set.

Solid colors only Elements on these layers must use solid colors and sharp edges. Use one solid color per layer. Do not use gradients, feathering, or anti-aliasing on the subpicture layers. Color gradations are not possible in subpictures.

Color definitions control look in button states Although you create layers for each color, the color numbers (1, 2, or 3), not the color values you used, are stored in the overlay. The color set is the color key or index, and contains the color values. (As mentioned below, Encore will automatically generate a color set based on the color in each layer.)

Layer visibility controlled in color set You use the opacity setting in the color set to control the visibility of elements in each state. You do not use the Eye icon  in the Layers panel in Photoshop.

Different color definitions for each state Colors are defined in the Encore Menu Color Set dialog box. For each color, you can specify a different color and opacity setting. By varying the colors and their opacity in each state, the highlighting can look quite different, even though it uses the same overlay. For example, color 1 might be transparent for the normal state (opacity set to zero), red for the selected state, and blue for the activated state. So all elements on layers with the (=1) prefix would not appear in the normal state, would be red in the selected state, and blue in the activated state.

Automatic color set generated from layers While the colors you use in the layers do not become part of the actual subpicture overlay, Encore does create a color set based on those values. By applying the colors you want for the selected state of the button to the three layers, you are able to design the highlight color in Photoshop and save time editing the color set in Encore.

Layers represent areas of color, not states It is important to understand that the subpicture layers represent color areas that correspond to the color set. They do *not* represent the activation states of the button.

Therefore, while the same subpicture overlay is used for each state, you can vary which elements in the subpicture are visible by changing the opacity and color definitions in each state.

Create a subpicture in Photosho

1. In either the Project or Menus panel, select the menu containing buttons that need subpictures.
2. Choose Edit > Edit Menu In Photoshop or click the Edit Menu In Photoshop tool  in the Tools panel.
Photoshop starts, displaying the selected menu.
3. In the Photoshop Layers panel, select the button layer set for which you want to create a subpicture.
4. Create a new layer and add the prefix (=1) to the beginning of the name.

On this layer, create the subpicture elements that you want displayed using color 1. Elements should consist of a single, solid color, without gradients, feathering, or anti-aliasing. Remember that you can control the visibility of these elements in each state in the color set. If necessary, you can create more than one layer for this color (for example, if you want text and a button outline in this color). Each layer for this color should have the same prefix.



Set the color and opacity of all elements on the layer as you want the layer to appear in the selected state. (All items should use the same values.) When you import the menu, Encore automatically generates a color set using this color definition and opacity value for the selected and activated state.

5. If you want a multicolored subpicture, repeat steps 3 and 4 for colors 2 and 3, using the layer-name prefixes (=2) for color 2 and (=3) for color 3.
6. If you want to create subpictures for another button, repeat steps 3 through 5.
7. In Photoshop, choose File > Save, and then File > Close.

Photoshop saves the file to the project folder. It does not overwrite the original file that you imported into your project.

Note: *When you import a menu into Encore, it creates a copy of the menu. The Edit In Photoshop command opens this copy, not the original file. Photoshop saves any changes to the copy. If you want to update the original as well, it is important to first save the copy so that your project contains the revised menu. Once saved, you can also save the changes to the original file*

using the *File > Save As* command in Photoshop or the *Menu > Save Menu As File* command in Encore.



8. Define the colors and opacity values used in each button state, and assign a highlight group to each button as desired.

 You can let Encore automatically generate a subpicture for the text of a button. The advantage of using this button property is that it regenerates the subpicture for you if you edit the text. See [Update subpicture text automatically](#).

View subpictures

[To the top](#)

You can view the subpictures in the Menu Viewer in each of the button states. These views show the subpictures of all the buttons at the same time using the menu's assigned color set and each button's Highlight group. To preview the subpictures with the mouse or a simulated remote control, see [Preview a project](#).

1. Open the menu that you want to preview.
2. At the bottom of the Menu Viewer, click one of the following buttons to see the subpictures of all the buttons for a particular state:
 -  Shows the button subpictures using the Normal color settings from the color set.
 -  Shows the button subpictures using the Selected color settings from the color set.
 -  Shows the button subpictures using the Activated color settings from the color set.

 To improve menu display performance, turn off the subpicture views when you're finished viewing subpictures.

 Twitter™ and Facebook posts are not covered under the terms of Creative Commons.

[Legal Notices](#) | [Online Privacy Policy](#)

Creating menus

Methods for creating menus

Create menus using predesigned assets

Add objects to a menu

Methods for creating menus

[To the top](#)

You can create menus using any of the following methods:

Predesigned menus You can customize the numerous predesigned menus included in the Library panel and on the application DVD. These menus give your project a professional look quickly and easily.

Predesigned buttons and backgrounds You can start with a predesigned menu background and use the predesigned buttons included in the Library panel to create menus right in Encore.

Assets from projects You can compose a menu using any visual asset that you import into your project. You can use both still and moving images for either the background or buttons.

Photoshop You can design menus in Photoshop and import them as menu assets into your project.

When you create a new menu, Encore automatically assigns a menu name based on the asset's filename. You can change this name and add a description in the Properties panel. (See [Name menus and buttons](#).)

Create menus using predesigned assets

[To the top](#)

An easy way to begin a project is to base your menu on the predesigned menus, buttons, images, and shapes found in the Library panel.

In addition to standard definition, Encore provides an assortment of high-definition menu templates and other assets, and distinguishes them with an "HD" in their names. These can be used for any type of project (DVD, Blu-ray, or Flash) and Encore will automatically scale them to the desired menu size when you build the project.



Note: You can use standard-definition menu templates in Blu-ray projects, but rather than scaling up, Encore will create a standard-definition menu on the Blu-ray disc.

Create a menu based on a predesigned menu

You can create a menu quickly using predefined menus from the Library panel. You can use a menu as is, just changing the text, or you can swap out images that better reflect the look and feel of your project. The buttons on the Library panel let you view the elements of the current set by type: menus, buttons, images, backgrounds, layer sets, text, shapes, and replacement layers.

When you select an item, its preview appears at the top of the panel. Many menus have a companion submenu that reflects the same style and contains a different number of buttons. The menus include buttons with subpictures (for highlighting when the button is selected) and fully styled placeholders for text. The buttons on some menus provide a thumbnail layer for video.

Note: Menus in the Library panel can be saved as regular menus (PSD) or as menu templates (EM). Regular menus include a background and buttons, but no settings or links are stored. Menu templates include additional information such as menu settings and background video and audio clips. (See [About menu templates](#).)

1. In the Library panel, select the set you want to view from the Set menu, and then click the Toggle Display Of Menus button  to display the predesigned menus.
2. Select the menu that you want to use, and click the New Menu button  at the bottom of the Library panel. (Press the Up Arrow and Down Arrow keys to browse through the templates.)

The new menu appears in the Menu Viewer, and the menu is added to the Project panel.

3. Edit the menu to suit the needs of your project:
 - Edit the text. In the Tools panel, click the appropriate text tool. Then, click in the menu to create a new text object, or click an existing text layer and edit the text as desired.
 - Delete or duplicate buttons as desired. (See [Cut, copy, or duplicate a menu object](#).)
 - Set links from the buttons to other submenus or to items in the Project panel. (See [Buttons and navigation](#).)

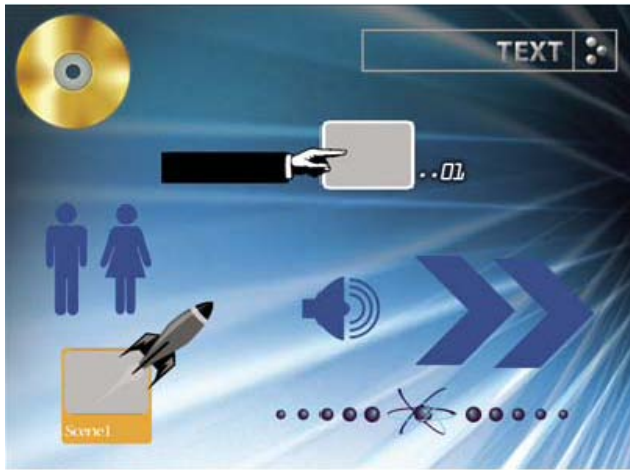

Create a menu based on a background and other assets

Instead of using a predesigned menu template to create a menu, you can piece together a menu starting with a predesigned background, and then add buttons, images, shapes, and replacement layers included with Encore. These objects are located in the Library panel.



Sample buttons and design items from Library panel

Each button includes subpictures that define how the button looks when selected (highlighted) or activated. The buttons are in layer sets together with the subpictures, so you can adjust individual elements or the entire button easily using the Layers panel.

1. In the Library panel, select the set that you want to view from the Set menu, and then click the Toggle Display Of Backgrounds button .
2. Select the background you want to use, and click the New Menu button  at the bottom of the panel.
A new menu appears in the Menu Viewer, and the menu is added to the Project panel.
3. Add buttons and other design elements as desired.
For example, to add a predesigned button, click the Toggle Display Of Buttons icon  in the Library panel, and then drag a button from the list into the Menu Viewer.
4. Edit the menu items as needed.

Add objects to a menu

[To the top](#)

You can add still images, buttons, or other assets to a menu. The technique you use depends on the source of the object. To automatically create buttons and build the links to those assets, simply drag the assets (such as video, menus, or timelines) to a menu.

Buttons, in order to function as individual navigation links, cannot overlap each other. As you add buttons to a menu, Encore highlights any that overlap with a bright red outline.

 *Predesigned high-definition assets in the Library panel are marked with an “HD” in their names. You can use them for any type of project (DVD, Blu-ray, or Flash).*

Add objects from the Library panel to a menu

1. Open the menu to which you want to add a Library panel element.
2. In the Library panel, select the set you want to view from the Set menu, and then click any of the icons to display the items for that type.

For example, click the Toggle Display Of Buttons icon  to display only buttons.

 *Shift-click any of the icons to view multiple categories. Alt-click (Windows) or Option-click (Mac OS) any of the icons to view all categories.*

3. Select the desired item in the Library panel, and either click the Place button  or drag the item from the panel to the Menu Viewer. Repeat until you have placed all the items you need.

If you click the Place button repeatedly, Encore aligns buttons in a grid, starting along the left edge of the title-safe guide. You can then select them and move them as a group.

4. Position and resize the items as needed.

Add assets from the Project panel to a menu

1. Create or open a menu.
2. Drag the asset (such as a video file, timeline, or menu) from the Project panel to the menu in the Menu Viewer.

If you drag a timeline or slide show to a blank area in the menu, Encore creates a button that is set as the default button for the set selected in the Library panel, and links it to the destination. If you drag a video file, a timeline is also created. If you drag such an asset to an existing button, its

contents and link are replaced.

Add still images to the menu background

You can include still images in a menu as part of the background.

1. Open an existing menu or create a new one.
2. In the Project panel, drag the desired image to the Menu Viewer.
3. Using the Direct Select tool , position and size the image as necessary.

(If you want to use the still image as a button, select the image and choose Object > Convert To Button.)

Note: *You can also drag an image from Adobe Bridge directly to the menu.*

More Help topics



[Legal Notices](#) | [Online Privacy Policy](#)

Multi-page menus for blu-ray discs

Create a multi-page menu in Encore

Multi-page menu display

A multi-page menu is a single PSD file containing multiple pages that are linked to each other. A page is a layer group in the PSD file containing buttons. The buttons link to parts of the menu, or to a chapter point in the timeline.

Note: *Multi-page menus are supported only on blu-ray discs. For DVDs, a multi-page menu is converted to a single-page menu with no changes in functionality.*

Buttons in page other than Page 0 are designated as Page <Page Number>: Scene <Scene Number> in the Properties panel. Flowcharts work with multi-page menus in the same way as they do for single page menus. As with single-page menus, you cannot use the pick whip for multi-page pop-up menus.

Note: *Animated buttons are not supported by multi-page menus.*

Create a multi-page menu in Encore

[To the top](#)

1. Select Window > Library.
2. Drag a menu from the Library panel to the Menu panel. This menu provides the template for the new pages that you create.
3. Select Menu > Add New Page.
4. In the Layers panel, double-click the page. In the Rename Layer dialog, enter a name for the page.
5. Create new buttons on the page, or copy buttons from other pages.
6. Link the buttons to pages, buttons, chapter points, or assets.
7. To navigate the pages in the menu, use the Show Previous Page and Show Next Page buttons in the menu editor. The navigation provides you with the browsing sequence of the pages.

Create chapter index for multi-page menus

1. Create a menu, and convert the buttons to chapter buttons using the property panel.
2. Create a timeline with chapter markers.
3. Link the first chapter button to the first chapter marker in the timeline.
4. Select Menu > Create Multi Page Chapter Index.

Hide buttons in the Flowchart view

1. Select the thumbnail of the menu containing the buttons that you want to hide.
2. Right-click the thumbnail.
3. Clear Show Buttons.

Delete pages from menus

1. In the Project panel, double-click the menu containing the page you want to delete.
2. Click inside the Menu editor.
3. In the Layers panel, select the page you want to delete.
4. Press Delete.

Multi-page menu display

[To the top](#)

If you have not customized the browsing sequence, the first page of the multi-page menu (Page 0) is displayed first when the user opens the disc. Thereafter, the pages are browsed sequentially. The ordering of the pages in the layer panel (ascending order), decides the default navigation for the pages. You can override the default navigation by linking the pages according to your requirement using buttons.

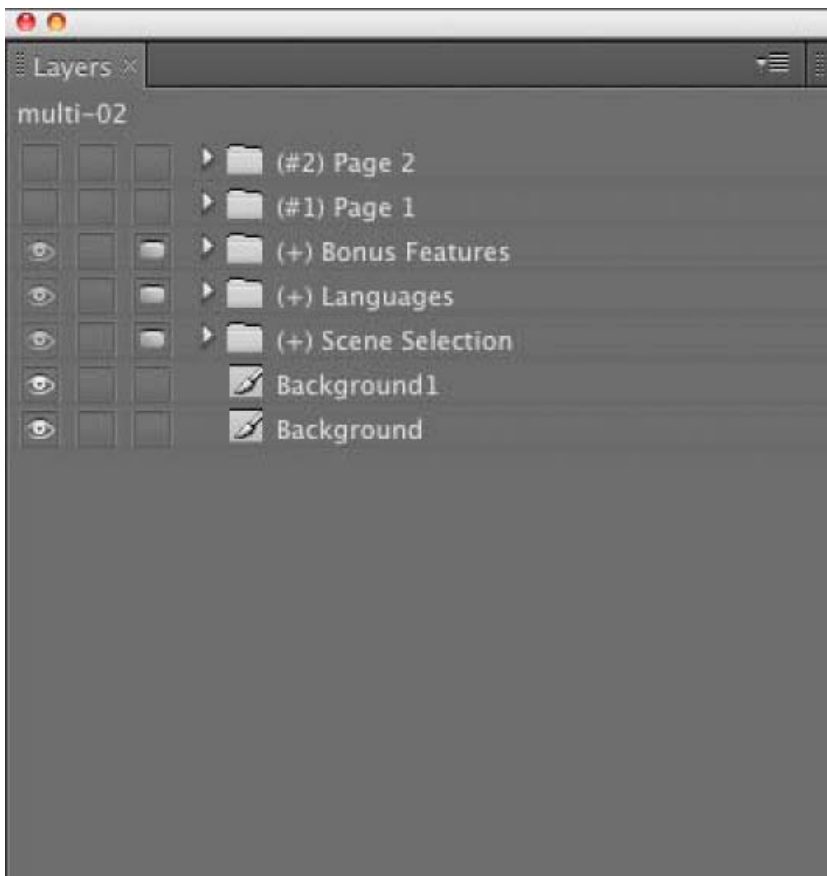

Layers view of the multi-page menu

Note: There is no group called Page 0. Page 0 is a logical container unlike other pages. Layers that lay outside the layer groups for pages belong to Page 0.

[More Help topics](#)



[Legal Notices](#) | [Online Privacy Policy](#)

Using Photoshop to create menus

- [About creating menus in Photoshop](#)
- [Create a multi-page menu in Photoshop](#)
- [Layer name prefixes for menus](#)
- [Edit a menu in Photoshop](#)

About creating menus in Photoshop

[To the top](#)

Encore is designed to work directly with Adobe Photoshop to build and edit menus and buttons. You can create entire menus or elements for menus (such as buttons and backgrounds) in Photoshop and import them directly into Encore. You can also edit Encore menus at any time in Photoshop, and have the changes updated immediately.

Menus, including the menus created in Encore, use the Photoshop PSD file format. All layers and layer sets you create in Photoshop remain intact when you import them into a project. If you follow the layer-naming convention, Encore automatically recognizes button sets, button subpictures, replacement layers, and video thumbnails. After importing, you can edit or modify the menu, or return to Photoshop to fine-tune it using the extensive design tools in Photoshop.

 *Visit Resource Center on the Adobe website to view a tutorial about editing menus in Photoshop.*

When creating menus in Photoshop, consider the following:

Menu size Set the size and pixel aspect ratio of your background images and menus to match the frame dimensions and pixel aspect ratio of your TV standard. Photoshop includes preset image sizes for digital video projects.

Format	Frame dimensions (in pixels)	Pixel aspect ratio	Equivalent frame dimensions in square pixels
NTSC fullscreen (standard definition)	720 x 480	0.9	720 x 534
NTSC widescreen (standard definition)	720 x 480	1.2	854 x 480
PAL fullscreen (standard definition)	720 x 576	1.07	768 x 576
PAL widescreen (standard definition)	720 x 576	1.42	1024 x 576
High-definition formats	1280 x 720	1.0	1280 x 720
	1440 x 1080	1.33	1920 x 1080
	1920 x 1080	1.0	1920 x 1080

Button size Create buttons at least 70 x 60 pixels in size to guarantee their visibility on a television.

Number of buttons Include no more than 36 buttons for a fullscreen (4:3 aspect ratio) menu or 18 buttons for a widescreen (16:9) aspect ratio.

Graphic elements Use vector shapes and masks, rather than bitmaps, where possible, because scaling these elements does not affect their quality. If creating pixelated content, such as buttons and logos, make sure that you create them at the largest size needed for the disc. If you want to resize some elements, it is better to scale a pixelated object down, rather than up. (Scaling images up can cause quality loss; scaling images down does not.)

RGB color Create your images using RGB color. Convert any CMYK images to RGB before importing them into Encore.

NTSC colors Use only NTSC-safe colors if you want to play your project on an NTSC television display. You can create colors in your graphics application that are beyond the color range that NTSC televisions can display. These colors can cause an unwanted halo effect. Use RGB values from 0 through 255.

Horizontal lines Set lines at three pixels or greater. Horizontal lines thinner than three pixels flicker when displayed on a television screen.

Font size Use a font size of 20 points or greater to ensure that the viewer can comfortably read titles and button text.

 *For a video tutorial on creating menus in Photoshop, see www.adobe.com/go/vid0241.*

[To the top](#)

Create a multi-page menu in Photoshop

Prefix the name of the group with (#) for Encore to recognize the group as a page.

1. Open a file in Photoshop, and select Window > Layers.
2. Click inside the Layers panel, and select Layer > New > Group.
3. In the New Group dialog, enter (#) <Page Name>. For example, to name the page Page 1, enter (#) Page 1.
4. Create button groups within the page.
5. Repeat the steps to create as many pages as you require.
 - 💡 Duplicate the page layer, and rename the buttons if you are planning to maintain a uniform appearance across pages.
6. Save the menu in the corresponding Library folder as a PSD file.
7. Open Encore, and select Windows > Library.
8. In the Set menu, select the category in which you have saved the PSD file. For example, if you had saved your file in the Corporate folder, select Corporate.
9. Select the PSD in the library panel, and drag it to the menu panel.
10. Link the buttons to pages, buttons, chapter points, or assets.
11. To navigate the pages in the menu, use the arrow buttons. The navigation provides you with the browsing sequence of the pages.

Note: The icon <insert image> denotes a multi-page menu, and the icon <insert image> denotes a multi-page pop-up menu.

Layer name prefixes for menus

[To the top](#)

For Encore to recognize the components of a menu from Photoshop, add predefined prefixes to the layer names. The prefixes identify the layers as button sets, video thumbnails, replacement layers, and button subpictures. This lets you import a finished menu that is ready to use in the project. You can also manipulate and change elements from within Encore.

💡 Instead of creating menus from scratch in Photoshop and adding all the prefixes manually, you may want to open a menu template that's similar to the one you want to create, save it as a Photoshop file, and then edit the exported file in Photoshop.

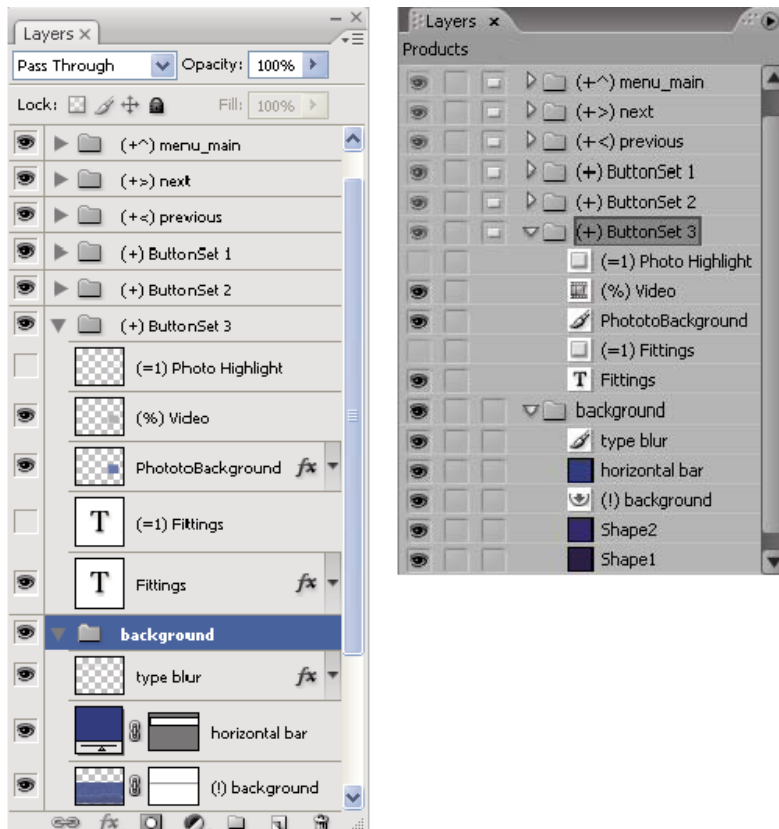

Layers panel in Photoshop (left) compared to the same layers in Layers panel in Encore (right)

The following layer-name prefixes identify the components of your menu.

Menu item	Photoshop component	Layer-name prefix	Example
-----------	---------------------	-------------------	---------

Button Name	Layer set that contains button components	(+)	(+)Daisy button 1
Chapter Button	Layer set that links to the chapter in a timeline or slide show when chapter indexes are created See About chapter indexes	(+#)	(+#)Chapter 1
Next Button	Layer set that links to the next submenu when chapter indexes are created	(+>)	(+>)Next
Previous Button	Layer set that links to the previous submenu when chapter indexes are created	(+<)	(+<)Previous
Main Button	Layer set that links to the main menu when chapter indexes are created	(+^)	(+^)Main Menu
Button Text	Text layers within the button layer set		Daisy button
Button Image	Image layers within the button layer set		Daisy image
Button Subpictures (optional)	Single-color image layers. Each layer represents one color of the three-color button subpictures See Create subpictures in Photoshop	(=1) (=2) (=3)	(=1)Text highlight (=2)Daisy outline (=3)Check mark
Video Thumbnail (optional)	Image layer within the layer set that serves as a placeholder for video See Create video thumbnail buttons	(%)	(%)Daisy thumbnail
Replacement Layer	Layer that acts as a drop zone for images See About replacement layers	(!)	(!)Daisy image
Other design elements or text (such as logo or menu title)	Individual layer	None required	Summer Flowers

Edit a menu in Photoshop

[To the top](#)

As your project evolves, you may want to change elements in a menu. Encore is designed to work directly with Photoshop. Without closing the project, you can jump to Photoshop to refine any menu, even menus created in Encore. Once you save the changes in Photoshop, the changes automatically appear in Encore.

1. Select the menu that you want to edit in either the Project or Menu panel.
2. Choose Edit > Edit Menu In Photoshop, or click the Edit Menu In Photoshop button  in the Tools panel.
Photoshop starts, displaying the selected menu.
3. Make changes as necessary.
4. In Photoshop, choose File > Save, and then File > Close.

Photoshop saves the file to the project folder. It does not overwrite the original file that you imported into your project.

Note: When you import a menu into Encore, it creates a copy of the menu. The Edit Menu In Photoshop command opens this copy, not the original file. Photoshop saves any changes to the copy. If you want to update the original as well, be sure to first save the copy so that your project contains the revised menu. Once the copy is saved, you can also save changes to the original file by choosing File > Save As In Photoshop or Menu > Save Menu As File In Encore.

More Help topics

[Video about creating menus in Photoshop](#)



[Legal Notices](#) | [Online Privacy Policy](#)

Edit and style menus

Select objects

Move, align, and space menu objects

Change the stacking order of menu objects

Cut, copy, or duplicate a menu object

Move or copy a menu object into another layer set

Replace a menu with another menu

Convert an object to a button

Convert a button or replacement layer to an object

Styling and transforming menu objects

Apply styles and transformations

Select objects

[To the top](#)

To edit objects on a menu, you need to select them first using one of the selection tools. The Tools panel contains two selection tools for editing objects:

Selection tool  Selects an entire button set (a button, its text, and subpictures together) so that it can be manipulated as a unit.

Direct Select tool  Selects individual layers so that they can be manipulated on their own.

Note: The Move tool  does not select objects. The Move tool is used for moving objects after you select them. (See *Move menu objects or layer sets.*)





A

B

Selecting objects

A. Selected button **B.** Selected layer

When selecting objects, remember that each object is on a separate layer and that the layers are stacked one on top of another. Using the selection tools, you can select objects on lower layers as long as you click at a point where no other object overlaps. Using the Layers panel, you can easily select objects individually, even when several elements overlap.

1. Open the menu that you want to modify.
2. Do one of the following:
 - Click an object directly in the Menu Viewer using either the Selection tool  to select a button or the Direct Select tool  to select a layer. Shift-click each additional object that you want to select.
 - Using the Selection tool, drag a box (or marquee) around one or more objects in the Menu Viewer.
 - In the Layers panel, click the object's layer or the layer set. Shift-click each additional layer or layer set that you want to select.

Selection handles appear on all the selected items in the Menu Viewer. When you select a button, a heavy outline appears. This outline encompasses all elements within the button.

Move, align, and space menu objects

[To the top](#)

Move objects in a menu

When a menu contains multiple objects, it's often difficult to select just the object you want to move. The Layers panel or context menu can help

you isolate an object before moving it.

Move menu objects or layer sets

1. Open the menu that you want to modify.
2. In the Menu Viewer or Layers panel, use a selection tool to select the object or layer set you want to move. (See Select objects.)
3. In the Menu Viewer, do one of the following:
 - Drag the button set or object in the menu using the appropriate selection tool. Shift-drag to constrain the movement horizontally, vertically, or diagonally. To create a copy and move the copy to a new location, hold down Alt (Windows) or Option (Mac OS) and drag it.
 - To prevent a different object from being selected, click the Move tool  in the Tools panel, and then drag anywhere in the Menu Viewer to move the selected object.
 - Press an arrow key to nudge an object one pixel at a time. Press Shift+arrow key to move an object 10 pixels at a time.

Move an object within a stack

In some cases, you may not be able to click directly on a layer to select it because the layer is obscured by overlapping layers. Using the context menu lets you select a layer within a stack in the Menu Viewer. To prevent another layer from being selected accidentally when you try to move the layer within a stack, you use the Move tool.

1. Using a selection tool, right-click (Windows) or Control-click (Mac OS) the stacked objects in the Menu Viewer.
2. Choose Select from the context menu, and then choose a named object in the list.
3. Click the Move tool , and then drag the object to the desired location. To view a menu of the object's layers, Ctrl+right-click (Windows) or Command+Control-click (Mac OS).

Another way to select an object within a stack is by using the Layers panel.

Align menu objects

Using the Align command, you can easily align buttons and subpictures with each other or with other design elements in a menu. Encore gives you several options for aligning objects. You can align the left, center, or right edges on the vertical axis; or you can align the top, middle, or bottom on the horizontal axis. You can either align the objects relative to each other or align them to the title safe area. Alignment always occurs within a rectangle, either to the title safe area or the bounding box that encompasses all the objects. The Align Center option, for example, centers the objects within this rectangle.

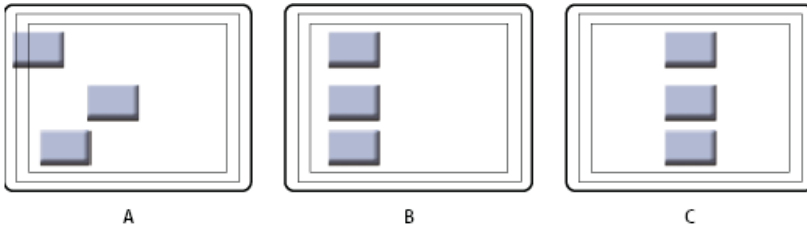

Comparison of the Align Center command with and without Relative To Safe Areas selected

A. Original position **B.** Align Center with Relative To Safe Areas off **C.** Align Center with Relative To Safe Areas on

1. Open the menu that you want to modify.
2. In the Menu Viewer or Layers panel, select the objects you want to align.
3. Choose Object > Align > Relative To Safe Areas if you want the objects aligned to the title safe area and the option is not already selected.

Note: A check mark next to the Relative To Safe Areas indicates it is turned on. To turn the option off, choose it again (Object > Align > Relative To Safe Areas).

4. Choose Object > Align and one of the following options:

Left Aligns the left sides of the selected objects to either the left side of the title safe area or the leftmost object.

Center Aligns on a vertical axis the center of the selected objects to either the center of the title safe area or to the center of a bounding box that encompasses all the objects.

Right Aligns the right side of the selected objects to either the right side of the title safe area or the rightmost object.

Top Aligns the top of the selected objects to either the top of the title safe area or the topmost object.

Middle Aligns on a horizontal axis the middle of the selected objects to either the center of the title safe area or the center of a bounding box that encompasses all the objects.

Bottom Aligns the bottom of the selected objects to either the bottom of the title safe area or the lowest object.

Distribute menu objects

If you want a series of buttons or objects to be evenly spaced, you don't need to calculate the appropriate distance between them. The distribute options can place them evenly apart for you, either horizontally or vertically. You can choose to distribute them between the two outermost objects or between the borders of the title safe area.

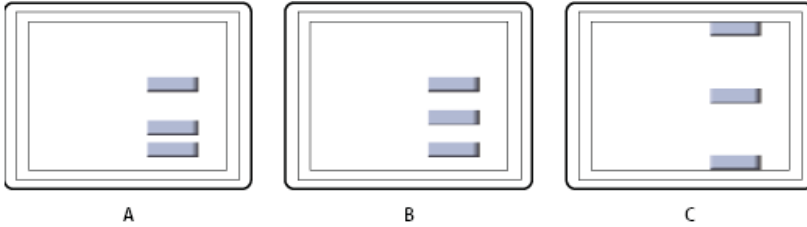

Distributed objects

A. Original position **B.** Distribute Vertically with Relative To Safe Areas turned off **C.** Distribute Vertically with Relative To Safe Areas turned on

1. Open the menu that you want to modify.
2. In the Menu Viewer or Layers panel, select the objects you want to distribute.
3. Choose Object > Distribute > Relative To Safe Areas if you want the objects distributed relative to the title safe area and the option is not already selected.

Note: A check mark next to the Relative To Safe Areas indicates it is turned on. To turn the option off, choose it again.

4. Choose Object > Distribute, and then choose one of the following from the list that appears:

Vertically Distributes the objects evenly between the top and bottom boundaries of the title-safe area (if Relative To Safe Areas is turned on) or between the topmost and bottommost objects (if Relative To Safe Areas is turned off).

Horizontally Distributes the objects evenly between the left and right boundaries of the title-safe area (if Relative To Safe Areas is turned on) or between the leftmost and rightmost objects (if Relative To Safe Areas is turned off).

Change the stacking order of menu objects

[To the top](#)

As in Photoshop, the stacking order in the Layers panel determines whether the content of a layer or layer set appears in front of or behind other elements in the menu. When you create or import a menu, the background is always the bottommost layer. A menu can have only one background, and it must remain the bottom layer.



Comparison of object in front (left) and sent backward with Arrange command (right)

1. Open the menu that you want to modify.
2. In the Menu Viewer, select the object you want to move in the stacking order.
3. Choose Object > Arrange, and then choose one of the following:
 - Bring To Front to move the selected item to the front.
 - Bring Forward to move the selected item one level forward.
 - Send Backward to move the selected item one level backward.
 - Send To Back to move the selected item to the back.

Cut, copy, or duplicate a menu object

[To the top](#)

1. Open the menu that you want to modify.
2. In the Menu Viewer or Layers panel, select the object.
3. Do one of the following:
 - To remove the object, choose Edit > Clear, or press the Delete key.
 - To duplicate the object, choose Edit > Duplicate. Encore duplicates the object, offsetting it from the original. If the object was in a layer set, it copies the object to the top layer of the same layer set.
 - To copy the object and move it to a new location, hold down Alt (Windows) or Option (Mac OS) and drag the object.
 - To copy the object and paste it into the same menu, choose Edit > Copy. Then choose Edit > Paste.
 - To copy the object and paste into a different menu, choose Edit > Copy. Then open the other menu in the Menu Viewer, and without selecting anything, choose Edit > Paste. The object is pasted in the same position as in the original menu.

Move or copy a menu object into another layer set

[To the top](#)

1. Open the menu that you want to modify.
2. In the Menu Viewer or Layers panel, select the object.

For multilayered menus, it is easier to use the Layers panel to select the object.
3. Choose Edit > Cut to move the object or Edit > Copy to copy it.
4. In the Layers panel, open the layer set into which you want to add the object, and select any object in the layer set.
5. Choose Edit > Paste.

Encore adds the object to the top layer of the layer set. You can also use the Object > Arrange commands to change the order of objects.

Replace a menu with another menu

[To the top](#)

If you want to change the menu design after you create a menu, you can use the Replace Menu command. When you replace a menu, Encore preserves menu settings, including button links, button order, and loop count.

1. Open the menu in the Menu Viewer.
2. Specify the replacement menu by doing one of the following:
 - Select a menu template in the Library panel, and click the Replace button .
 - Choose Menu > Replace Menu, navigate to the desired menu, and click Open.

The appearance and layout of the menu are replaced by those of the new menu. If the new replacement menu contains more buttons than exist in the original menu, the extra buttons link to no destination. If the replacement menu contains fewer buttons, the buttons from the original menu are preserved, but in the style of the default button in the replacement menu. Both the original menu and its replacement must have at least one button.

Convert an object to a button

[To the top](#)

When you convert an object to a button, Encore creates a layer set with the prefix denoting a button set (+) attached to the name. It places the object into the layer set and creates a subpicture for the button. If you convert an object's layer set into a button, Encore creates a subpicture layer only if one doesn't already exist.

1. Open the menu that you want to modify.
2. In the Menu Viewer or Layers panel, select the object you want to convert to a button. Select multiple objects to convert them all to buttons at the same time or select a layer set to convert the entire set into a button.
3. Choose Object > Convert To Button, or click the Button column next to the image layer in the Layers panel.

Note: Buttons cannot overlap other buttons in order to function as individual links. Encore highlights overlapping buttons in red to use as a guide and a reminder.

Convert a button or replacement layer to an object

[To the top](#)

When you convert a button to an object, you remove linking and navigation capabilities from the button. When you convert a replacement layer to an object, you remove the ability to replace the layer's contents by dragging and dropping.

1. Open the menu that you want to modify.

2. In the Menu Viewer or Layers panel, select one or more buttons or replacement layers that you want to convert to objects.
3. Choose Object > Convert To Object.

Styling and transforming menu objects

[To the top](#)

About predefined styles

Styles let you quickly change the appearance of a layer or object in a menu. Styles are predesigned Photoshop layer effects, such as shadows, glows, bevels, overlays, and strokes, that you can apply to most layers in a menu. Once applied, the effects are linked to the object. When you move or edit the object, the effects change with the object.

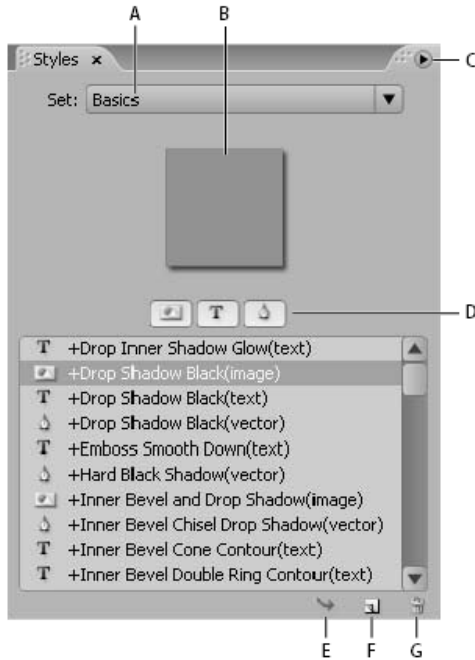

Styles panel

A. Name of currently displayed set **B.** Preview of selected style **C.** Panel menu with additional options **D.** Buttons to display different types of styles: Image, Text, and Shape **E.** Apply Style **F.** New Item **G.** Delete Item

The Styles panel divides styles into three categories: Image, Text, and Shape. You can apply any style to an individual layer, except subpicture highlight layers—layers with the (=1), (=2), or (=3) prefix. When styles are applied to layer sets or buttons, they affect the layers within the set according to their style category. The layers they affect depend upon the category:

Image Applies the style to all layers in a layer set (except highlight layers).

Text **T** Applies the style to the first text layer in a layer set that is not a highlight layer.

Shapes Applies the style to the first shape layer in a layer set that is not a highlight layer.

Styles generally fully replace any existing effects applied to a layer. The Styles panel includes a few styles that add to the existing effects in a layer rather than completely restyle it. Additive styles have a plus sign (+) at the beginning of their names. You can create your own styles and add them to the Styles panel, or group styles into sets. (See About creating styles.)

Apply styles and transformations

[To the top](#)

Apply a style to a button or layer set

1. Select the button in the Menu Viewer or in the Layers panel.
2. In the Styles panel, select the style, and click the Apply Style button .

If your menu contains a styled layer that you like, you can quickly create a new style by dragging the layer directly to the Styles panel. The new style contains any effects applied to the layer. (See About creating styles.)

Add a drop shadow

Drop shadows add depth to a menu. You can apply the drop shadow effect to any object in the menu, be it text, buttons, or other graphic element.

Encore gives you extensive control over the look of the shadow, letting you specify its color, opacity, angle, offset, size, and spread. You apply drop shadows to individual elements or to layer sets. Because the effect is applied to the element, when you move or resize the element, or edit the text, the drop shadow moves, resizes, or changes shape accordingly. If you apply a drop shadow to a button or layer set, Encore applies it to

the bottommost layer.

 *The Styles panel contains many predesigned Photoshop layer effects, including drop shadows, that let you quickly change the look of a button or other element. See About predefined styles.*

1. Open the menu containing the buttons you want to modify.
2. In the Layers panel, click the layer of the element to which you want to add a drop shadow. If the element is in a layer set, you may need to open the layer set first.
3. Choose Object > Drop Shadow, and select Drop Shadow in the Drop Shadow dialog box.
4. To change the color, click the color swatch.
5. In the Color Picker dialog box, adjust the color using one of the following methods (the color you select appears in the top half of the color swatch; the original color remains in the bottom half):
 - Locate the color range you want by dragging the triangle sliders on the color spectrum bar, and then click a color in the color field.
 - Click the buttons for Hue, Saturation, and Brightness, or Red, Green, and Blue (the color field changes for each button you click), and then click in the color field to select a new color.
 - Change the number values by either clicking each one and typing a new value, or by dragging the double-arrow pointer left or right over the number to decrease or increase the value.
 - Type a new hexadecimal color value in the # text box.
6. Click OK to close the Color Picker.

The new color replaces the original color in the Drop Shadow dialog box.

7. To change the other properties of the drop shadow, drag the double-arrow pointer left or right over a value to decrease or increase it. You can click the Preview option off and on to see the before and after effects of each property.

Opacity Sets the opacity of the shadow.

Angle Specifies the lighting angle of the shadow.

Distance Specifies how far the shadow should be offset from the object.

Size Sets the size of the shadow.

Spread Expands the boundaries of the shadow.

8. To apply the drop shadow, click OK.

Drop shadows applied using Object > Drop Shadow may be replaced or removed when you apply a predefined style.

 *You can edit the drop shadow in Photoshop when you're editing the menu.*

Rotate menu objects

1. In the Menu Viewer, select one or more objects.
2. Do one of the following:
 - To rotate in 90° increments, choose Object > Rotate > 180°, 90° CW (clockwise), or 90° CCW (counter-clockwise).
 - To rotate in any increment, click the Rotate tool  in the Tools panel, and drag from outside one of the object's eight selection handles (the pointer becomes a curved, two-sided arrow). Drag left to rotate counterclockwise or right to rotate clockwise. Holding down the Shift key constrains rotation to 45° increments. Items rotate around their center points.

Resize (scale) menu objects

As you fine-tune your menu, you often need to adjust the size of the elements. You scale objects on a menu manually with the mouse. You can scale multiple objects or layer sets together as a group.

1. Open the menu that you want to modify.
2. In the Menu Viewer or Layers panel, select the objects you want to scale.
3. Do one of the following:
 - Drag a handle.
 - To proportionally scale the object, Shift-drag a handle.
 - To scale from the object's center point, hold down the Alt key (Windows) or Option key (Mac OS) and drag a handle. (The center point maintains its position on the page.)
 - To scale proportionally from the object's center point, hold down Shift-Alt (Windows) or Shift-Option (Mac OS) and drag a

handle. (The center point maintains its position on the page.)

Note: If multiple items are selected, dragging the handle of one object scales all the objects at the same time.

Flip menu objects

You can flip an object in a menu either horizontally or vertically.



A

B

C

Comparison of flipping object horizontally and vertically

A. Object as originally placed **B.** Flipped horizontally **C.** Flipped vertically

1. Open the menu containing the object you want to flip.
2. In the Menu Viewer or Layers panel, select the object (or objects) you want to flip.
3. Choose either Object > Flip Horizontal or Object > Flip Vertical.

More Help topics



[Legal Notices](#) | [Online Privacy Policy](#)

Adding text to menus

- [About text in menus](#)
- [Character panel overview](#)
- [Add and format text](#)

About text in menus

[To the top](#)

Encore lets you type text directly onto a menu. You can type text either horizontally or vertically, and either freely or constrained to a bounding box. In addition to providing standard control over the appearance of the type, Encore also lets you transform a text block as if it were an object. You can edit the text you add to a menu in either Encore or Photoshop. Any changes you make to the text in Photoshop appear in the Encore menu.

The Tools panel contains two different text tools: the Text tool **T** and the Vertical Text tool **↓T**. Using either tool, you can enter text either freely or within a bounding box.

To enter text freely, you simply click where you want the text to begin. You control how the text wraps by using the Enter key. The text is not constrained. Typing text freely is convenient for quickly entering single words, such as on buttons.

To enter text within a bounding box, you first drag the pointer to define the text block. When you type, the text wraps when it reaches the edge of the box. While you can continue to enter text when the type hits the bottom (or edge for vertical type), Encore displays only the text that fits in the box. The bounding box can be useful when trying to arrange type in a specific area of the menu. You can resize the bounding box, which causes the text to reflow, changing the line endings and possibly how many lines of text display.



Comparison of entering text freely (left) or within bounding box (right)

Note: Encore supports Text On A Path created in Photoshop, even though it does not provide the layout tools to create it from scratch.

To exit text mode and commit the text changes, you can press the Esc key. (For more keyboard shortcuts, see [Using keyboard shortcuts](#).)

Character panel overview

[To the top](#)

Encore gives you advanced typographic control over your text. Using the Character panel, you can kern, track, shift the baseline, and scale text. You can set type attributes before you enter characters, or you can restyle and reformat existing text. The Character panel also provides various formatting options for Asian text. Most of the options in the panel let you either type a value or select from a menu of preset values. (To apply formatting options, see [Format text](#).)

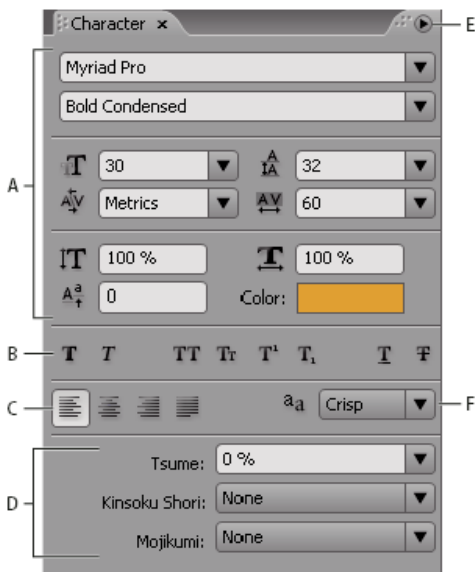

Character panel with Asian text options displayed

- A.** Fonts and font attributes
- B.** Font Style buttons
- C.** Alignment options
- D.** Asian Text options
- E.** Character panel menu
- F.** Text Anti-alias

Fonts and font attributes

The Character panel gives you precise control over individual characters including font, size, color, leading, kerning, tracking, and baseline shift. You can also stretch or shrink the type using horizontal or vertical scaling and apply color. (To apply font attributes, see Format text.)



Fonts and font attributes in the Character panel

A. Font **B.** Font Style **C.** Font Size **D.** Kerning **E.** Vertical Scale **F.** Baseline Shift **G.** Leading **H.** Tracking **I.** Horizontal Scale **J.** Color

Font Specifies the font for the text.

Font Style Determines the font style, such as Medium, Oblique, Bold, or Bold Oblique. (The options depend upon the selected font.)

Font Size Sets the point size of the font.

Kerning Kerns the letters on either side of the insertion point. Kerning sets the space between specific letter pairs. To give the appearance of more even spacing, some letter pairs look better if pushed closer together, such as “VA” or “Te.” A positive value loosens the space between letter pairs; a negative value tightens the space. Most fonts come with preset kerning values for specific letter pairs. Metric uses the font’s original kerning values.

Note: You cannot apply kerning across a range of selected characters. Kerning works only when an insertion point is placed between a pair of characters.

Vertically Scale Stretches or shrinks the text vertically, relative to the baseline.

Baseline Shift Shifts type from its baseline. A positive value raises the type; a negative value lowers it.

Leading Sets the leading (the amount of space between lines of type measured baseline to baseline). Auto sets the leading at 120% of the font size of the text. If characters on a line have different settings, Encore uses the largest leading value for the entire line.

Tracking Applies tracking values to insert or remove space evenly through the selected text. Positive tracking values move the characters apart; negative tracking values move characters closer together.

Horizontally Scale Stretches or shrinks the text horizontally.

Color Applies color to the text. Click the color to display the Color Picker dialog box.

Font style buttons

The style buttons on the Character panel let you apply multiple type styles to text. (To apply font styles, see Format text.)

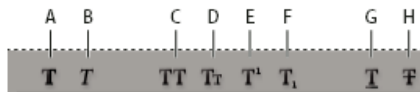

Font style buttons in the Character panel

A. Faux Bold **B.** Faux Italic **C.** All Caps **D.** Small Caps **E.** Superscript **F.** Subscript **G.** Underline **H.** Strike through

Faux Bold Applies a simulated or faux bold style to the selected text. (To apply the actual bold style included with the font, if any, choose it from the Font Style pop-up menu on the Character panel.)

Faux Italic Applies a simulated or faux italic style to the selected type. (To apply the actual italic style included with the font, if any, choose it from the Font Style pop-up menu on the Character panel.)

All Caps Capitalizes all the letters in the selected text.

Small Caps Replaces all the lowercase letters in the selected text with small capitals.

Superscript Converts the selected text to a superscript. Superscript characters are reduced in size and shifted above the type baseline.

Subscript Converts the selected text to a subscript. Subscript characters are reduced in size and shifted below the type baseline.

Underline Underlines the selected text.

Strike Through Changes the selected text to strike through characters.

Alignment options

The alignment options on the Character panel set the alignment for an entire paragraph. In vertical text blocks, the alignment options change to match the orientation of the text. Align Left and Align Right become Align Top and Align Bottom, while Center Align and Justify Last Left adjust text between the top and bottom of the text block. (To apply alignment options, see Format text.)

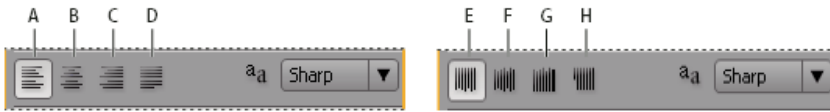

Alignment options in the Character panel

A. Align Left B. Align Center C. Align Right D. Justify Last Left E. Align Top F. Align Center G. Align Bottom H. Justify Last Top

Text anti-alias options

Anti-aliasing smooths the jagged edges of text by softening the color transition between the edge pixels of the characters and the background pixels. Anti-aliasing applies to all the characters in the text block. (To apply anti-aliasing, see Format text.)

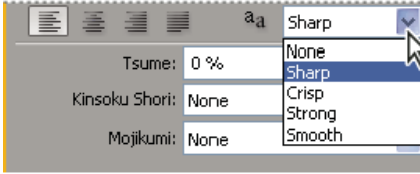

Anti-aliasing options in Character panel

The Text Antialias Mode option **aa** in the Character panel has five possible settings:

None Turns off anti-aliasing for all characters in the text block.

Sharp Slightly reduces the jagged edges of the characters, applying the minimal amount of anti-aliasing.

Crisp Sharpens the edges of the characters.

Strong Makes the characters appear heavier.

Smooth Makes the characters appear smoother by softening the transition between the edge pixels and the background.

Asian text options

The Character panel includes several options for formatting Chinese, Japanese, and Korean (CJK) characters (also known as double-byte or multibyte characters). You can toggle the display of these options within the panel by choosing Show Asian Text Options from the Character panel menu. (The Character panel menu contains additional options for Asian text. To apply the Asian text options, see Format text.)

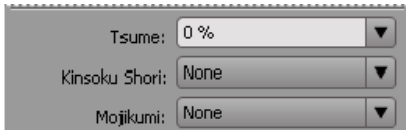

Asian text options in Character panel

Tsume Reduces the space around a character by the specified percentage. Encore reduces the spacing around both sides of the character equally. The greater the percentage, the tighter the compression between characters. At 100% (the maximum value), there is no space between the character's bounding box and its em box.

Kinsoku Shori Determines line breaks in Japanese type. Characters that cannot begin a line or end a line are known as kinsoku characters. Encore includes weak and maximum kinsoku sets. The None option turns off the use of kinsoku shori. The options JIS Weak or JIS Maximum prevent the following characters from beginning or ending a line.

JIS Weak set	JIS Maximum set
Characters that can't begin a line ' " 、 。 々 > 》 」] } } > ♪ ・ ー ♪ !) . . : ; ?] }	Characters that can't begin a line !) , . : ; ?] } ♪ - ' " % ° ° C ° F 、 。 々 > 》 」] }] あいうえおつやゆよわ ^ ^ > ♪ アイウエオツヤユヨワカケ ・ ー ♪ ♪ ! %) . . : ; ?] }
Characters that can't end a line ‘ “ < << 『 『 『 [[[[[{	Characters that can't end a line ([{ £ \$ ‘ “ < << 『 『 『 [『 [# \$ (@ [{ ¥

Mojikumi Determines spacing between punctuation, symbols, numbers, and other character classes in Japanese type. Encore includes several predefined mojikumi sets.

- None turns off the use of mojikumi.
- Mojikumi Set 1 uses half-width spacing for punctuation.

- Mojikumi Set 2 uses full-width spacing for all characters except the last character in the line.
- Mojikumi Set 3 uses half-width spacing for punctuation and full-width spacing for other characters, including the last character in the line.
- Mojikumi Set 4 uses full-width spacing for all characters.

Push In First Prioritizes moving characters up to the previous line to prevent prohibited kinsoku characters from ending or beginning a line.

Push Out First Prioritizes moving characters down a line to prevent prohibited kinsoku characters from ending or beginning a line.

Push Out Only Always moves characters down a line to prevent prohibited kinsoku characters from ending or beginning a line.

Burasagari Allows single-byte periods, double-byte periods, single-byte commas, and double-byte commas to fall outside the paragraph bounding box.

Bottom-To-Bottom Leading Measures the space between lines of type from baseline to baseline. (The bottom of most characters rests on the baseline.)

Top-To-Top Leading Measures the spacing between lines of type from the top of one line to the top of the next line.

Vertical text options

The Character panel menu contains several options that apply to vertical text. You can rotate characters, control line breaks, and set the method used to calculate leading. (To apply character options, see Format text.)

Rotate Character Changes the orientation of the selected characters from vertical to horizontal. Each character rotates 90° on its own axis within the line of type, resulting in one character placed above the next. You cannot rotate horizontal text or double-byte characters. (Full-width characters are only available in Chinese, Japanese, and Korean fonts.) Therefore, any double-byte characters in the selected range will not be rotated.

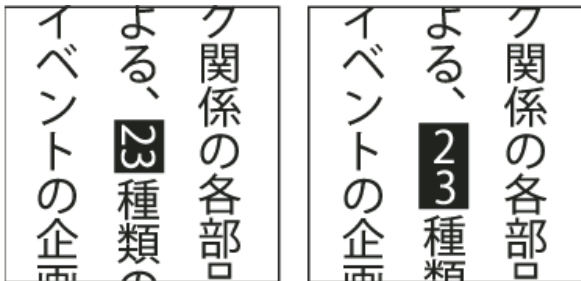

Original text (left) and text with rotation applied (right)

Tate-chuu-yoko (Also called kumimoji and renmoji) Changes the orientation of the characters from vertical to horizontal. The characters rotate 90° as a group. You can select, edit, and format the rotated text just as you do the vertically oriented characters. These features are often used to combine Asian and Roman characters and cannot be applied to horizontal text.

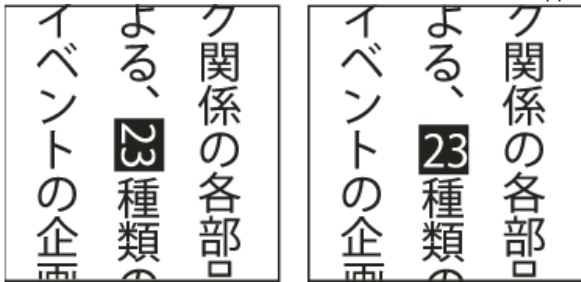

Original text (left) and text with tate-chuu-yoko applied (right)

Add and format text

[To the top](#)

Add text to a menu

1. Open the menu to which you want to add text.
2. Select either the Vertical Text or Horizontal Text tool from the Tools panel. The pointer changes to an I-beam within a dotted box. The small horizontal line near the bottom of the I-beam marks the baseline on which the text rests.
3. Do one of the following:
 - Position the baseline of the I-beam pointer where you want the text to be located, and click to set the entry point for the text. The insertion point appears.
 - Drag the I-beam pointer to define the bounding box for the text. When you release the mouse button, the insertion point appears. Its location is determined by the alignment option set in the Character panel.
4. In the Character panel, select the attributes you want for the text. (See Character panel overview.)

You can change the orientation of vertical text by using the Rotate Character command in the Character panel menu.

5. Type the desired text.

To exit text mode and commit the text changes, you can press the Esc key. (For more keyboard shortcuts, see [Using keyboard shortcuts](#).)

Resize the text bounding box

1. Open the menu containing the text block.
2. Select either the Vertical Text or Horizontal Text tool from the Tools panel.
3. Click an insertion point in the text.

The text bounding box appears.

Note: If you don't see a bounding box, you entered the text freely and must manually change the line breaks.

4. Position the pointer over a selection handle. When it changes to a double-headed arrow, drag the handle to resize the bounding box. The text reflows within the box.



Resizing a text bounding box with overflowed text

Important: Be sure to use a text tool when resizing the text block. If you drag a bounding box handle using a selection tool, it scales the text as if it were an object, and the text does not reflow.

Select text

Before you can format or change type, you must select it. To change a range of characters, a word, or paragraph within a text block, you select the text using the Text tool. You use the Direct Select tool or the text layer in the Layers panel to select the entire block of text.

You can drag, scale, rotate, align, and distribute a text block as you would to transform any other object in the menu.

Select individual characters, words, or paragraphs

1. Open the menu that you want to edit.
2. Select a text tool from the Tools panel, and do one of the following:
 - Drag-select the type. (Shift-click to extend or reduce an existing selection.)
 - Double-click a word to select it.
 - To select one word to the right, click an insertion point and press Shift+Ctrl+Right Arrow (Windows) or Shift+Command+Right Arrow (Mac OS).
 - To select one word to the left, click an insertion point and press Shift+Ctrl+Left Arrow (Windows) or Shift+Command+Left Arrow (Mac OS).
 - To select just the line, triple-click a line within a paragraph.
 - To select the entire paragraph, quadruple-click within a paragraph.
 - To select the previous paragraph, click an insertion point at the beginning of a paragraph, and press Shift+Ctrl+Up Arrow (Windows) or Shift+Command+Up Arrow (Mac OS).
 - To select the next paragraph, click an insertion point at the end of a paragraph, and press Shift+Ctrl+Down Arrow (Windows) twice or Shift+Command+Down Arrow (Mac OS) twice.

For more keyboard shortcuts on selecting text, such as entire blocks of text, see [Keys for working with text in menus and subtitles](#).

Transform a text block

1. Open the menu that you want to edit.
2. Select the text block by using one of the following techniques:
 - Click the text directly in the Menu Viewer using the Direct Select tool .

- In the Layers panel, click the text layer.
3. Transform the text block as you would any other object. (See Styling and transforming menu objects.)

Format text

You use the Character panel to change the font and other text attributes.

Change the attributes of characters, words, or paragraphs

1. Open the menu that you want to edit.
2. Select the characters, words, or paragraphs you want to change.
3. In the Character panel, select the type attributes you want for the text. (See Character panel overview.)

Change the attributes of all the text in a text block

1. Open the menu that you want to edit.
2. Do one of the following actions:
 - Click an insertion point within the text block using the appropriate text tool, and choose Edit > Select All.
 - Using the Direct Select tool , click the text block or button containing the text block.
 - In the Layers panel, click the text's layer or the layer set containing the text.
3. In the Character panel, select the type attributes you want for the text. (See Character panel overview.)



[Legal Notices](#) | [Online Privacy Policy](#)

Button routing and numbering

Renumber buttons

Specify an offset for the button numbers

Change the routing preferences

Exclude Previous and Next buttons from button routing

Change the routing order

Set a button to activate automatically

Renumber buttons

[To the top](#)

Encore assigns each button a number. Viewers can select buttons by using the remote control. You can renumber buttons within a menu. Button numbers must start at 1 and be sequential (no gaps between numbers).

1. Open the menu and select the button in the Menu Viewer.
2. Choose a new number from the Number pop-up menu in the Properties panel.

Encore renumbers the other buttons as necessary.

Specify an offset for the button numbers

[To the top](#)

To increase the button numbers so that they can match, for example, a scene or chapter number, you can specify an offset for the menu. The offset changes the effective starting point of the numbers.

1. Select the menu in the Project panel or Menus panel.
2. In the Properties panel, type a number for Offset.

Change the routing preferences

[To the top](#)

Routing is the button-to-button path the cursor follows when moved by the arrow buttons of a remote control. For most projects, Encore can determine the standard routing pattern for you. If your project has special requirements or an unusual arrangement of buttons, you can customize the routing.

Encore provides four preset routing patterns. The default routing is a circular movement through the buttons on the same row or column. Right or left arrows move across the row in the appropriate direction, returning to the beginning of the same row. Up and down arrows follow the same rules and move up or down until the end of the column, returning to the top or bottom of the column in a circular fashion.

Using a preferences setting, you can change the routing so that when an arrow button reaches the end of a row or column, it moves to the beginning of the next row or column. You can also change the routing to be only horizontal or vertical, limiting movement, for example, across a row and not up or down.

1. Choose Edit > Preferences > Menus (Windows) or Encore > Preferences > Menus (Mac OS).
2. Click the routing preferences to select or deselect them.
3. Choose the desired wrap options from the appropriate pop-up menu.
4. Click OK.

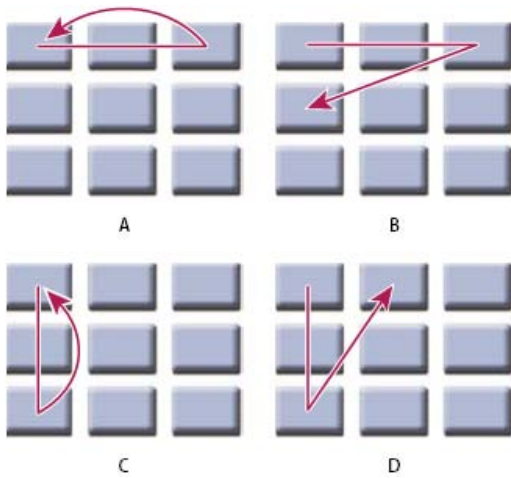

Comparison of the preset routing options for remote control buttons

A. Wrap around left/right, wrap within the same row (default) **B.** Wrap around left/right, wrap to the next row **C.** Wrap around up/down, wrap within same column **D.** Wrap around up/down, wrap to next column

Exclude Previous and Next buttons from button routing

[To the top](#)

Excluding Previous and Next buttons from auto-routing, the default links from first and last chapter buttons are used.

1. Choose Edit > Preferences > Menus (Windows) or Encore > Preferences > Menus (Mac OS).
2. Deselect Exclude Next/Previous Buttons.

Change the routing order

[To the top](#)

When you turn off automatic routing, you can manually set the path for the remote control through the menu buttons. You display the routing icons in the Menu Viewer.

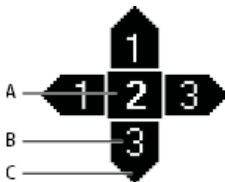

Routing icon

A. Button number **B.** Button selected by remote control arrow **C.** Arrow on remote control

The Routing icon shows you the number of the button. An arrow points from the center of the icon and contains a button number. The arrow represents the navigation button on the remote control. The button number represents the button to which that arrow on the remote control leads. To set a navigation arrow to a specific button, you simply drag it to the button.

1. Open the menu containing the buttons whose routing order you want to change.
2. Click the Show Button Routing button  at the bottom of the Menu Viewer.
Encore displays a routing icon in each button.
3. In the Properties panel, click Automatically Route Buttons to deselect it.
4. Place the Selection tool over the routing arrow you want to modify. The Selection tool changes from a pointer to a hand. Drag it to the button you want to be next in the routing order. Repeat this step until you have modified the routing of all the buttons you want to change.

Set a button to activate automatically

[To the top](#)

Normally, a button is activated when a viewer navigates to it with the remote control, and then presses Enter. You can set a button to activate automatically when the viewer simply navigates to it. The Auto Activate option is often used for arrow buttons and for creating hidden navigation (called Easter eggs).

An advanced authoring technique uses multiple versions of a menu that change when the viewer selects certain buttons. Instead of using subpictures to highlight a button, the buttons auto activate when selected and link to another version of the menu. The advantage to this approach is that you can use different images to simulate button selection. The drawback is that any video or audio playing in the background is interrupted.

1. In the Menus panel, select the desired menu or double-click the menu to open it in the Menu Viewer.

2. Select the button you want to auto activate. (In the Menu Viewer, use the Selection tool , not the Direct Select tool, so that you select the entire button set.)
 3. In the Properties panel, select Auto Activate to turn on the option for the selected button.
-



[Legal Notices](#) | [Online Privacy Policy](#)

Chapter indexes into linked menus

- [About chapter indexes](#)
- [Create a chapter index menu](#)
- [Create a chapter index](#)

About chapter indexes

[To the top](#)

A chapter index is a series of linked submenus that contain buttons that link to all the chapters in a timeline or slide show. Many DVDs contain an option for selecting from a list of chapters or scenes. If your video includes more chapters than can fit in a single menu, it can be time-consuming to link all the submenus together. When you use the Create Chapter Index command, you can generate the chapter submenus automatically.

For example, if your timeline has 18 chapter points, you can create a menu with six chapter buttons. When you choose Create Chapter Index, Encore generates three submenus, each containing six chapter buttons that link to the appropriate chapter points. Other navigation buttons, such as Next and Previous, are also updated automatically.

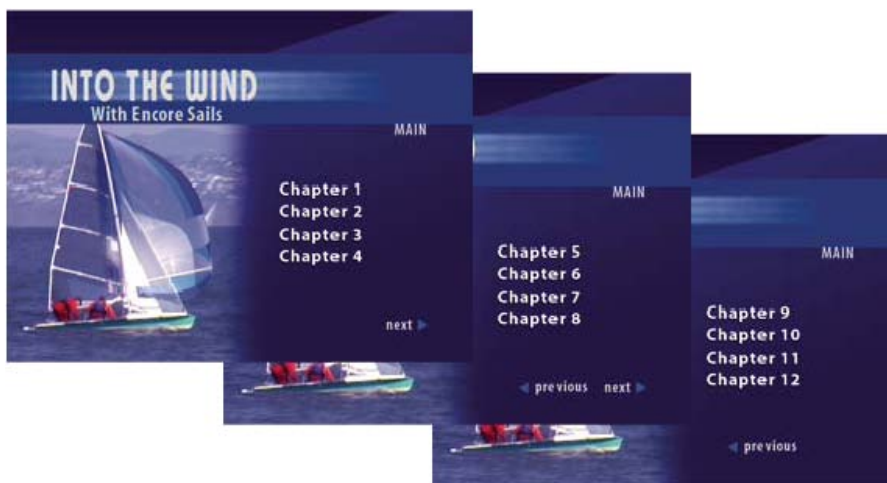

Automatically generated submenus

 For a tutorial on creating a chapter index, visit [Resource Center on the Adobe website](#).

Create a chapter index menu

[To the top](#)

A chapter index menu contains chapter buttons as well as navigation buttons to take the viewer through the menus that make up the chapter index. The key to creating a chapter index menu is assigning the appropriate button types to the buttons. The button types identify the buttons so Encore can link them correctly when generating the index. For example, Encore links chapter buttons to chapter points, but leaves normal buttons unchanged.

1. Create or open the menu to use as the chapter index menu.
2. Add the necessary navigation buttons, such as Main Menu, Next, and Previous, to the menu.

The Next and Previous buttons are linked automatically when the index chapters are generated. The Next and Previous buttons are hidden on the last and first submenus, respectively. If you do not include Next and Previous buttons on a menu that results in multiple submenus, Next and Previous buttons are created automatically. You can later change the appearance of these buttons.

3. Select a button, then in the Properties panel, choose the appropriate button setting from the Type menu. Repeat for each button in the menu. Encore assigns a special layer name prefix for each type of button. For example, Chapter buttons have (+#) at the beginning of their layer names. (For more information, see [Layer name prefixes for menus](#).)

Chapter Links to a chapter point on the timeline.

Next Lets viewers jump to the next submenu.

Previous Lets viewers jump to the previous submenu.

Main Links to the main menu. Before you create the index, add a link from the Main button to the main menu in your project.

Normal (default) Use for any other button.

4. Make sure that your chapter buttons are in the proper order. If necessary, select a button and reorder it using the Number menu in the Properties panel.
5. Add links for any other button (such as a Settings button) so that any additional submenus that are generated include those links.

Create a chapter index

[To the top](#)

1. Open the chapter index menu.
2. Make sure that at least one of the chapter buttons is linked to the timeline containing the chapter points.
3. Choose Menu > Create Chapter Index.

The chapter buttons are linked to the chapter points. If there are more chapter points than buttons, additional submenus are created.

4. Open each submenu in the Menu Viewer, and check the links and button names. Edit the button text and button properties as necessary.



[Legal Notices](#) | [Online Privacy Policy](#)

Creating styles for menu elements

About creating styles

Create a style in Photoshop

Add a new style to the Styles panel

Create a set in the Styles panel

Delete or rename a style set

About creating styles

[To the top](#)

Styles let you quickly change the appearance of an element in a menu. You can create your own styles and add them to style sets in the Encore Styles panel.

You create a style from a Photoshop file containing a single layer with layer styles (effects) applied to it. The layer type—image, text, or shape—determines its category in the Styles panel.

A style can either replace all the effects in a layer or add to the existing effects. Except for simple styles, you generally want a style to replace existing effects so that you get the same results each time you use it. You can control how a style changes a layer by the effects you include in the layer. You can also show or hide these layers in the Photoshop Layers panel. When creating a style, you can use either of the following methods:

- To entirely replace existing effects, you simply include the desired effects in the layer in the Photoshop file.
- To add to existing layer effects, you first apply all possible effects to the layer in the Photoshop file. You then hide the effects that are not part of the style definition by using the Eye icon in the Layers panel. Hidden effects indicate to Encore that those effects remain unchanged in the layer being styled. The predefined styles included with Encore that add effects, rather than completely restyle a layer, have names that begin with a plus sign (+).

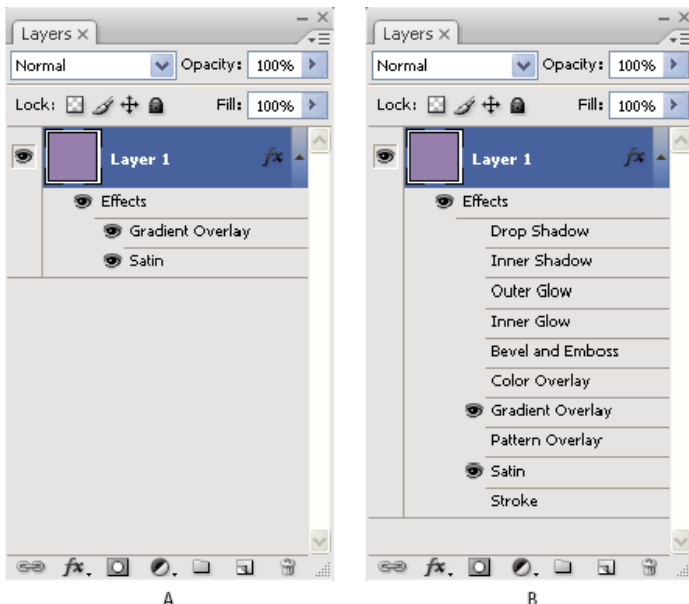

Comparison of two styles in Photoshop Layers panel

A. Replaces existing styles when applied in Encore **B.** Replaces only Gradient Overlay and Satin effects; hidden effects remain unchanged

Create a style in Photoshop

[To the top](#)

1. Open Photoshop and create an image. Set the image size to around 150 x 150 pixels, and delete the background layer to make the image transparent.
2. Type a character or draw a filled pixel shape or a shape layer.
3. Style the layer as desired by using the Layer Style dialog box (choose Layer > Layer Style and select a style from the list). To make the style add to existing effects rather than replace them, select every effect in the dialog box.
4. In the Layers panel, make sure that the effects you want applied are visible. Hide the effects you want left unchanged (so that

the visible effects are added to the layers but don't replace all the effects).

5. Choose File > Save. Name the file using the name you want to appear in the Encore Styles panel. If you created a style that adds to existing effects, place a plus sign (+) at the beginning of the name so it matches the existing additive styles.

Add a new style to the Styles panel

[To the top](#)

1. In the Encore Styles panel, select the set to which you want to add the style.
2. Click the New Item button .
3. Locate the PSD file containing the style you want to add, and click Open.

The style is added to the Styles panel. Its name matches the name of the file.

Create a set in the Styles panel

[To the top](#)

1. In the Styles panel, choose New Set from the Styles panel menu.
2. Type a name for the new set, and click OK.

Delete or rename a style set

[To the top](#)

1. In the Styles panel, select the custom set from the Set menu.
2. Choose Delete Set or Rename Set from the Styles panel menu.
3. Click OK or Yes.

More Help topics



[Legal Notices](#) | [Online Privacy Policy](#)

Menu color sets

[About color sets for menus](#)

[Define a menu color set](#)

[Automatic color set](#)

[Base a new color set on the Automatic color set](#)

[Assign color sets and highlight groups](#)

[Share color sets between projects](#)

[To the top](#)

About color sets for menus

Color sets specify the colors used in subpictures. Each menu can reference only one color set. However, a project can contain any number of sets. To maintain a consistent look throughout a project, a common approach is to use the same color set for all menus in a project. Using a limited number of color sets makes it easy to change the highlighting colors for the entire project at once.

Encore includes a predefined color set and generates an automatic color set when you import a menu. (See Automatic color set.) You can modify the default set or create your own sets. Once defined, you can save color sets and use them in other projects.

A color set consists of a maximum of 15 colors, each with its own opacity setting. The colors are divided among one color group for the normal state and two highlight groups. Each highlight group contains up to six colors: three for the selected state and three for the activated states. Any button can reference either of the highlight groups. You can use the highlight groups to distinguish between different types of buttons on the same menu. For example, you could assign Highlight Group 1 to the main navigation buttons in the menu (such as Play Movie), while using Highlight Group 2 for the common navigation buttons (such as Next and Previous).

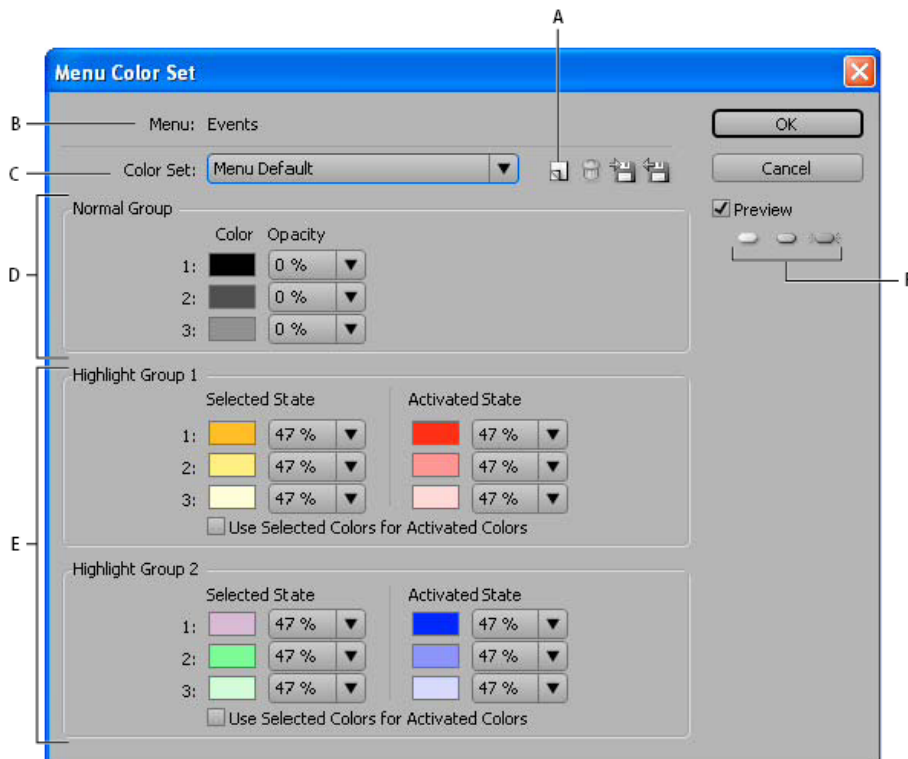

Menu Color Set dialog box

A. New color set **B.** Active menu **C.** Currently applied color set (and Color Set menu) **D.** Normal group **E.** Highlight group 1 and 2 **F.** Preview state buttons

The Menu Color Set dialog box contains the following options:

New Color Set Creates a color set based on the current color definitions, and adds its name to the Color Set pop-up menu.

Color Set menu Lets you choose a color set to display and apply to the currently active menu.

Delete Color Set Deletes the currently displayed color set.

Export To Color Set File Saves the current color set in a file so that it can be used in other projects. (A color set file has the .cs extension added to its name.)

Import From Color Set File Imports the color set you specify.





Normal Group Sets the colors and opacity values for the subpictures in the normal, unselected state.

Highlight Group 1 and 2 Sets the colors and opacity values for the subpictures in the selected and activated states. A button can reference one of these two groups.

Define a menu color set

[To the top](#)

When you define a color set, the colors are applied to the currently active menu.

1. Open the menu for which you want to create the color set, and then choose Menu > Edit Menu Color Set.
2. Click the New Color Set button .
3. Type the name of the new color set, and click OK.
4. Click Preview to preview the colors in the menu as you create them. Click the Normal button , the Selected button , or the Activated button  (below the Preview option) to see the colors for each state.
5. Click the color swatch of any color you want to change. The Color Picker dialog box appears.
6. If you want to limit your color selection to NTSC-safe colors, choose RGB colors from 0 through 255.
7. Adjust the color using one of the following methods (the color you select appears in the top half of the color swatch. The original color remains in the bottom half.):
 - Locate the color range you want using the triangle sliders on the color spectrum bar, and then click the desired color in the color field.
 - Change the numeric values for H (hue), S (saturation), B (brightness), R (red), G (green), or B (blue).
8. Click OK. The new color replaces the original color in the Menu Color Set dialog box.
9. Choose the desired opacity level from the Opacity pop-up menu adjacent to the color swatch.
10. To set the Activated State colors to the same values as the Selected State colors, select Use Selected Colors For Activated Colors.
11. Repeat steps 5 through 10 for any color you want to change.
12. Click OK when you have defined all the colors to your satisfaction.

Encore applies the new color set to the currently open menu.

Automatic color set

[To the top](#)

When you import a menu into your project, Encore looks at the colors and opacity settings in the subpicture layers and automatically generates a color set based on those values. The Automatic color set is different from other color sets. You cannot edit the automatic color set directly.

However, the automatic color set is updated when you edit the menu in Photoshop using the Edit Menu In Photoshop command.

Note: *Designing your subpictures in Photoshop and using the Automatic color set in Encore is a much simpler approach than creating them in Encore.*

To generate the Automatic color set, Encore reads the color and opacity settings in each subpicture layer in the menu, starting at the bottommost button (the button listed closest to the Background in the Layers panel), moving up:

- Highlight Group 1 is assigned the values from the bottommost button. Specifically, the layer with the prefix (=1) sets the values for color 1. Layers with prefixes (=2) and (=3) set the values for color 2 and color 3. The Selected and Activated states are set to the same values.
- Highlight Group 2 is assigned the color values from the first button containing subpicture color values that are different from the bottommost button. The Selected and Activated states are set to the same values.
- Normal group is set to 0% opacity (fully transparent), but uses the color values of the default color set.

Upon import, Encore not only generates the automatic color set, it also applies the appropriate highlight group to each button. If the subpicture colors in a button do not match either of the two highlight groups, Encore assigns Highlight Group 1 to them.

Base a new color set on the Automatic color set

[To the top](#)

The Automatic color set of each menu is automatically generated from the subpicture layers of the menus. To create an independent copy of an Automatic color set, create a color set based on the Automatic color set of the menu. This new set behaves like the regular color set, and can be assigned to other menus.

1. Select the menu containing the Automatic color set you want to copy in the Project or Menus panel.
2. Choose Menu > Edit Menu Color Set.
3. Click the New Color Set button , type a new name, and click OK.

4. Adjust the colors and opacity settings as needed. (See About color sets for menus.)
5. Click OK when you have defined all the colors to your satisfaction. Encore applies the new colors to the menu.

 To dynamically update the color set to reflect changes you make in Photoshop, switch back to the Automatic color set.

Assign color sets and highlight groups

[To the top](#)

To each menu, you can apply one color set. To each button within the menu, you can apply one highlight group. Use the Properties panel to change the color set of a menu or the highlight group assigned to its buttons. Select multiple menus or buttons to change the color set of several menus at once or the highlight group of the buttons.

Change the color set of menus

1. In the Menus panel, select the menu that you want to change. (Shift-click or Ctrl+Command-click to select additional menus.)
2. In the Properties panel, select the desired color set from the Color Set pop-up menu at the bottom of the panel.

Encore assigns the selected color set to the menu, changing the colors used for the subpictures of its buttons.

Note: If you choose the Automatic color set, Encore generates a unique color set based on the colors used in the subpicture layers of each individual menu. (See Automatic color set.)

Change the color group of buttons

1. In the Menus panel, select the appropriate menu. To select additional menus, Ctrl-click (Windows) or Command-click (Mac OS).
2. Select the button you want to change. To select additional buttons, Ctrl-click (Windows) or Command-click (Mac OS).
3. In the Properties panel, select the desired color group from the Highlight pop-up menu. Encore assigns the selected Color Group to the subpicture of the button or buttons.

Share color sets between projects

[To the top](#)

You can share color sets between projects. You can export a customized color set from one project, and import the color set into another project.

Export a color set

1. Open a menu that uses the color set you want to export.
2. Choose Menu > Edit Menu Color Set.
3. Select the color set from the Color Set menu.
4. Click the Export To Color Set Files button .
5. Type a new name for the color set, browse for the appropriate folder in which to save it, and click Save.
Encore saves the color set, adding the extension .cs to the filename.
6. Click OK.

Import a color set

1. Open a menu to which you want to apply the imported color set.
2. Choose Menu > Edit Menu Color Set.
3. Click the Import Color Set From File button , locate and select the file, and click Open.
4. Click OK.

Encore applies the color set to the active menu.



Menu templates

- [About menu templates](#)
- [Create menu templates](#)
- [Using menu templates on multiple computers](#)
- [Add custom menus to the Library panel](#)
- [Save a menu as a PSD file](#)
- [About replacement layers](#)
- [Create replacement layers](#)

About menu templates

[To the top](#)

The Library panel can include either standard menus or menu templates. A menu is a Photoshop (PSD) file that includes a background and buttons. A menu template is an EM file that includes a Photoshop file. This file also includes the menu name and description, duration and loop settings, and references to background audio and video clips.

You can add menus and menu templates to the Library panel for easy reuse.

For video tutorials about using Photoshop and After Effects to create and animate menu assets, see www.adobe.com/go/vid0241 and www.adobe.com/go/vid0258.

Create menu templates

[To the top](#)

Custom menu templates provide an easy way to create menus that you can use over and over again in your Encore projects. Menu templates help you create motion menus. Assets such as video and audio files that you use to create the menu are saved as references within the menu template file. When you open a menu template in Encore, any referenced assets are also loaded into your project. Regular menus have a .psd filename extension, while menu templates have an .em filename extension.

1. Open an existing menu, or use Photoshop to create a menu, and then import the Photoshop file as a menu.
2. Include any video or audio in the menu background that you want to use in the menu template.
3. Choose Menu > Save Menu As Template.
4. To make it easy to transfer the menu template to a different computer, select Self-Contained. (See Using menu templates on multiple computers.)
5. Specify the filename and location of the menu template, and then click Save.

When you save a menu as a template, two files are created: the template (EM) file and a Photoshop (PSD) file that contains the menu layer information. In addition, video and audio assets are created if the menu includes a motion background. The menu template (EM) file automatically appears in the Library panel the next time you start Encore.

Note: *The filename you specify for the template does not affect the original filename of the menu. Whenever you reuse the template, the menu's original name appears in the Project panel (not the template's filename).*

Using menu templates on multiple computers

[To the top](#)

When creating a menu template, you can select the Self-Contained option, which determines how the menu template is saved in the folder structure on disk. If you select this option, Encore creates a folder in the same location and with the same name as the menu template (EM) file. This folder includes the Photoshop (PSD) file and any assets used in the menu background, making the menu template easy to transfer to a different computer.

If you don't select Self-Contained, Encore saves the PSD file in the same folder as the EM file, but the assets are not included. You can move a regular menu template to a different location on the same computer. When you move a template to another computer, ensure that the linked assets are also on the target computer in the same location.

Add custom menus to the Library panel

[To the top](#)

1. Open an existing menu, or use Photoshop to create a menu, and then import the Photoshop file as a menu.
2. Drag the menu from the Project panel to the Library panel.
3. Select whether you want to add the menu as a standard menu or as a menu template. If you specify menu template, select

Self-Contained if you want to easily transfer the menu template to a different computer.

Standard menus appear in the Library panel as PSD files, and menu templates appear as EM files.

Save a menu as a PSD file

[To the top](#)

1. Open the menu, or select it in the Project panel.
2. Choose **Menu > Save Menu As File**. Specify the filename and location, and then click **Save**.

The menu is saved as a Photoshop (PSD) file.

About replacement layers

[To the top](#)

A replacement layer is a special placeholder layer that lets you drag an image onto an area of your menu while maintaining masks and layer effects. Replacement layers are especially useful in menu templates to easily swap in your own images while maintaining the overall design of the menu. For example, if you make wedding DVDs, you can create a menu template that includes a placeholder layer for the picture of the bride and groom. When creating a menu for a specific bride and groom, you simply drag the image from the Project panel to the replacement layer.

When you drop an image onto a replacement layer, the image replaces the fill of the replacement layer. The new image is scaled to the replacement layer's size, and the aspect ratio of the new image is preserved. Any masking or layer effects, such as drop shadows, glows, and transparencies, that you applied to the replacement layer are preserved.



Dragging an image to a replacement layer replaces the contents of the layer and scales the imported image to fit within the drop zone.

You can add replacement layers to the Library panel, where they're sorted in their own category. (See [Add items or sets to the Library](#).)

Create replacement layers

[To the top](#)

Do one of the following to create replacement layers:

- Convert an object in a menu to a replacement layer.
- Add a replacement layer to a menu in Photoshop, and then bring the menu back into your project.

The key to creating a replacement layer is to size the placeholder appropriately for the image or video.

Convert an object to a replacement layer

1. In the Menu Viewer, open the menu to which you want to add the replacement layer.
2. Using the Direct Select tool, select the object that you want to use as the replacement layer.
3. Choose **Object > Convert To Replacement Layer**.

Encore creates a layer set with the (!) prefix, which indicates a replacement layer.

4. Do any of the following:
 - If you're using the replacement layer as a design element, drag a still image from the Project panel or Library panel to the replacement layer. When the replacement layer is highlighted with a border, release the mouse button.
 - If you're using the replacement layer as a placeholder in a menu template, save the menu template. (See [Create menu templates](#).)

 *If too much of the image is cropped, edit the replacement layer or image in Photoshop.*

Create a replacement layer in Photoshop

1. Select the menu that you want to edit in the Project panel.
2. Choose **Edit > Edit Menu In Photoshop**, or click the **Edit Menu In Photoshop** tool  in the Tools panel.

Photoshop starts, displaying the selected menu.

3. Create a layer for the image. You can use a shape tool or import an image. (Adding a white or colored fill to the layer helps you see the replacement layer once you import it into Encore.)
4. (Optional) Add a mask or apply other layer effects.
Masks or layer effects in replacement layers are preserved when an image is dragged onto the layer in the Menu Viewer.
5. In the Layers panel, double-click the layer name of the placeholder image, and add (!) to the beginning of its name.
6. In Photoshop, choose File > Save, and then choose File > Close.

The changes are saved, and the menu is updated in Encore.

More Help topics

[Create menus in Photoshop video](#)

[Animate menus in After Effects video](#)

[Add items or sets to the Library](#)



[Legal Notices](#) | [Online Privacy Policy](#)

Menu timing and looping

- [About menu display time and looping](#)
- [Set menu display time and looping](#)
- [Set menu loop back](#)

[To the top](#)

About menu display time and looping

The default display setting for a still menu is Hold Forever, which displays the menu indefinitely. You can limit the menu active time and the timeout action if the user doesn't act when the menu is active. You limit the menu display time in videos that many users view, such as in information kiosks. When one viewer leaves, the video returns to the main menu so that it is ready for the next viewer.

Three settings control the display time and looping of a motion menu: Duration, Loop #, and Loop Point.

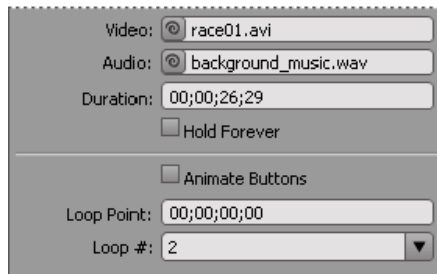

Menu display time and looping options in Properties panel

About Loop # and Duration

You can set the display time of a menu to a specific amount (called Duration). For motion menus, the Duration setting determines how long the menu plays before either repeating itself (defined by Loop #) or triggering the end action. The video or audio content of the menu plays within the confines of the Duration. The menu duration is set automatically to match the length of the video background or audio that you add to the menu. If the run time of the video or audio content exceeds the menu duration, the content is clipped. If the run time of the video background or audio is less than the duration, the content ends. (The background displays the last frame until the menu loops or ends.) For animated thumbnail buttons, if the run time of a video thumbnail button is less than the duration, it repeats until the menu loops or ends.

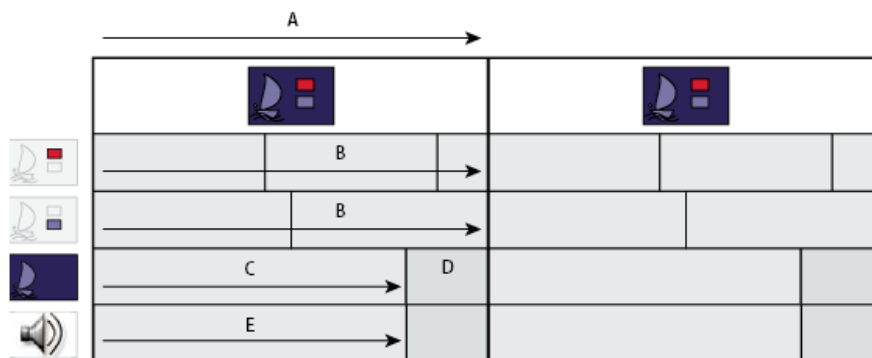

In this menu, duration exceeds length of video and audio content. Video background freezes on the last frame before the menu loops. Audio finishes and starts again only when menu loops. Thumbnails repeat until menu loops.

A. Menu duration B. Video thumbnails C. Video background D. Last frame E. Audio

About Loop Point

You can set motion menus to loop either a specific number of times or until the viewer activates a button (forever). When looping, all content begins again once the menu duration is reached. You specify a loop point to begin looping a point different from the starting point.

The loop point is used to initially disable the buttons. Until the loop point is reached, the viewer cannot select or activate a button. The menu returns to this point on each repetition, so the buttons are disabled only when the menu is first displayed. For any subsequent repetitions, the Duration is shorter and the start point of all video content in the menu is offset.

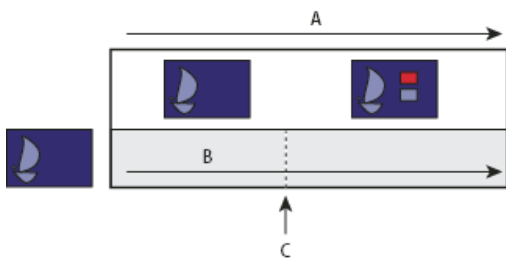

Buttons are inactive until background video reaches loop point. If the menu loops, it returns to the loop point, making the menu duration shorter.
A. Menu duration **B.** Background video **C.** Loop point

A loop point is often used when a menu has been animated in Adobe After Effects®. For example, you can create a video in After Effects in which the button images fly in from different points and settle into position after 15 seconds. In this case, the background video, not the menu, includes the button images. Except for those first 15 seconds, the button images would remain static for the remainder of the video (other elements could continue to move). The actual menu that uses this animation as its background could be simple. It would need just a placeholder background layer (to be replaced by the video) and button layer sets that contain only the button subpicture layers used for the selected and activated button states. (See About creating menus in After Effects.)

For the first 15 seconds that the menu is displayed, the buttons perform their animation. If you set the loop point to 15 seconds, you then disable the buttons during the animation. Only when the menu reaches the loop point do the buttons become active. If set to loop, it loops back to the loop point, not the beginning of the animation.

Set menu display time and looping

[To the top](#)

The Properties panel contains several options that control the display time and looping of a menu. The options you choose depend upon whether you created a still or motion menu. These options control whether video, audio, or thumbnail buttons play while the menu is displayed.

1. In the Project panel, select the desired motion menu.
2. In the Properties panel, click the Motion tab, and then do one or more of the following:
 - To set the menu display time to a fixed amount, enter a value for Duration.
 - To have the menu loop a set number of times, select or type a value for Loop #.
 - To have a menu loop until the viewer activates a button, select Forever from the Loop # menu.
 - To disable the menu buttons for a set amount of time, type a timecode value for Loop Point.
3. If you set the menu to display for a set duration or number of loops, the menu must have an end action. Click the Basic tab and specify a destination for End Action so that the menu has a destination once it times out.

Set menu loop back

[To the top](#)

You can set a loop point in a motion menu to a point from which you want the motion menu to loop, rather than the beginning. This is useful when the starting point and ending point of the motion menu are separated by a long interval.

1. Select the menu from the Menu panel.
2. On the Properties panel, set the loop point.
3. Select Specify Link from the End Action Options menu.
4. Select the target from the list, and then select Set To Loop Point, and click OK.



[Legal Notices](#) | [Online Privacy Policy](#)

Using After Effects to enhance menus

[About creating menus in After Effects](#)
[Overview of animating a menu](#)
[Create an After Effects composition from a menu](#)

About creating menus in After Effects

[To the top](#)

Encore and Adobe After Effects contain several integrated features to help you create dynamic motion menus. Using After Effects, you can animate elements of a menu so that, for example, the button images fly into position or fade in over an image or video. The composition you create can then act as a video background to the actual menu in the project. This advanced technique requires an understanding of After Effects, video backgrounds, and the use of the loop point to initially disable buttons.

In After Effects you can also create a menu from a composition and then import it as a menu into Encore. The After Effects Create Button command lets you assign button subpicture layers and a video thumbnail layer for each button set. It adds the appropriate layer-name prefixes to them. The Save Frame As command lets you save a frame as a layered Photoshop file. For information on creating buttons or layered Photoshop files in After Effects, see [Working with Adobe Encore and After Effects](#) in After Effects Help.

 For a tutorial on using After Effects to create a motion menu, see www.adobe.com/go/vid0258.

Overview of animating a menu

[To the top](#)

If you have After Effects 7.0 or later, you can use the Create After Effects Composition command in Encore to quickly start a menu animation. This command converts a menu into an After Effects composition and opens it in After Effects.

The basic steps to animate a menu using this command are as follows:

1. Create a complete version of the menu.

Using either Encore or Photoshop, design the menu that contains the elements you want to animate, as well as the final resting position of the text and button images. You use this menu as the basis for both the animation and the final menu. Place each element on its own layer so that you can animate the elements separately. Creating the composition from a complete version of the menu ensures that the button subpictures correctly overlay the buttons.

2. Create an After Effects composition from the menu.

If you created the menu in Photoshop, import it as a menu. Choose Menu > Create After Effects Composition in Encore to start After Effects and automatically convert the menu into a layered composition.

Each button set becomes a nested composition within the master menu composition. Because it is based on the actual menu, the composition contains the elements you want to animate and their correct ending position on the screen. If you animate the button images or delay their display initially, it is important to keep them visible for the remainder of the composition, because the image of the menu in the movie file acts as the visual menu in the project. In other words, the background video you create, not the menu, contains the button images. When the animation is complete, you create a rendered file from the composition.

 A good practice is to create a layer marker in After Effects at the frame where you want the animation to end and the menu looping to begin. Name this marker "Loop Point," and set an ending keyframe at this same location for each attribute you plan to animate. Doing this ensures that your button highlights line up correctly when you bring the finished animation into Encore.

3. Hide the animated layers in the original menu.

Using the Layers panel in Encore, hide all the layers that you animated so that they do not appear over the background video.

4. Import the video file and link it as a video background to the menu.

Import the video background you created as an asset into your Encore project. Then, using the Properties panel, link the video to the menu so that it replaces the menu background.

5. Set the menu Loop Point.

In Encore, use the menu property Loop Point to designate at what point in the display of the menu the buttons appear. Buttons cannot be selected or activated by the viewer until the Loop Point frame is reached. Once the menu starts looping, the buttons are enabled. The loop begins at the loop point and ends at the end of the movie file. The initial animation plays only when the menu first starts. (See About menu display time and looping.)

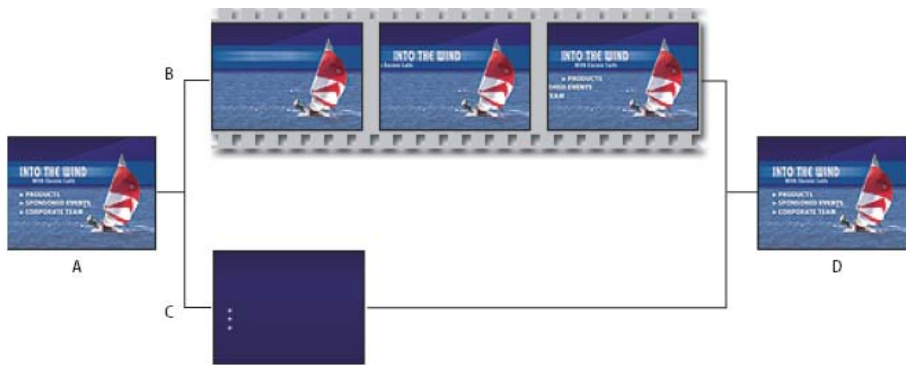

Animating menus using Create After Effects Composition command

A. Create complete version of menu. **B.** In After Effects, animate menu. **C.** In Encore, hide layers so that they don't appear over background video (only button subpictures should remain visible). **D.** Link menu in Encore with animated background from After Effects.

Encore lets you import and work with menus that aren't standard sizes. For example, you can import a 720 x 534-pixel menu (created using square pixels) into an NTSC project (frame size: 720 x 480 pixels). However, if you create a composition from a menu of these dimensions, you need to scale the layers in After Effects. To ensure that the menu in the project aligns precisely with the pixels in the background animation, it is best to resize nonstandard menus in Photoshop before you create the composition. For standard definition (SD), resize an NTSC menu to 720 x 480 pixels and a PAL menu to 720 x 576 pixels. For high definition, resize square-pixel menus to 1280 x 720 or 1920 x 1080 pixels, and resize nonsquare anamorphic menus to 1440 x 1080 pixels. (In Photoshop, you can also specify the pixel aspect ratio for the menu: For a SD NTSC menu, choose 0.9 for fullscreen or 1.2 for widescreen; for a SD PAL menu, choose 1.066 for fullscreen and 1.42 for widescreen. For HD square-pixel menus, choose the 1.0 pixel aspect ratio and for HD anamorphic menus, choose 1.333.)

Create an After Effects composition from a menu

[To the top](#)

1. In Encore, select the menu that you want to animate in the Project panel.

2. Choose Menu > Create After Effects Composition.

The menu saves as a PSD file and opens as a project in After Effects. The layer sets and buttons convert to nested compositions.

3. In After Effects, animate the menu elements as desired. Set keyframes for position, scale, rotation, or any effects at the times when you want the animation to start and stop. For example, you can have each of three buttons rotate for 5 seconds at staggered intervals. Don't make the button subpicture layers visible in the composition because they must remain part of the menu in Encore. Convert text layers to editable text if desired.

4. Render the movie as a video file. Choose Include Project Link from the output module settings in the Render Queue panel. You can return to After Effects directly from Encore to make adjustments if necessary.

5. In Encore, double-click the original menu to open it.

6. Choose File > Import As > Asset, select the video you created in After Effects, and click Open.

7. In the Layers panel in Encore, hide any layer that is visible in the composition by clicking the Eye icon next to the layer. If you animated the button images, open their button sets and hide the visible layers.

8. With the menu selected in the Project panel, click the Motion tab in the Properties panel, and drag the Video pick whip to the After Effects-produced video clip in the Project panel.

Because the menu is in animation, the video clip takes the place of the actual menu in Encore while still maintaining its original properties such as the button highlights.

9. Specify Loop Point and Loop # values. (See About menu display time and looping.)

For more information on using After Effects, see After Effects Help.

More Help topics

[Video about creating motion menus in After Effects](#)



[Legal Notices](#) | [Online Privacy Policy](#)

Video and audio in menus

[About motion menus](#)

[Blu-ray pop-up menus](#)

[Add a video background to a menu](#)

[Add audio to a menu](#)

[Create video thumbnail buttons](#)

[Set or change poster frames](#)

[Animate video thumbnail buttons](#)

About motion menus

[To the top](#)

A menu can include sound and motion. You can replace the entire background of a menu with a video file, as well as link it to an audio file. A video can serve as a moving backdrop to a menu or provide all the visual elements of the menu except for the button highlighting. The video can include, for example, a moving background, scrolling credits, and even the button images. The menu itself needs only to include a placeholder background and the button subpictures (in button layer sets) that align with the button images in the video.

How long the video background or audio plays and whether it loops depends on the duration and loop settings of the menu. (See [About menu display time and looping](#).)

To have a smaller image, resize or mask the video in Adobe Premiere® Pro or mask a portion of the video with a layer in the menu.

 *The Library panel contains menu template (EM) files that include video backgrounds.*

Blu-ray pop-up menus

[To the top](#)

For Blu-ray projects, you can create pop-up menus that can be attached to timelines that viewers can start, usually with their remote control. Pop-up menus appear transparently above the currently playing clip on a Blu-ray video. Blu-ray pop-up menus don't have the DVD video features such as end actions and motion menu items. These features include video and audio backgrounds, duration, loop point, and button transitions.

When you set a menu as a Blu-ray pop-up menu, you can set only the properties that apply to Blu-ray pop-up menus. These properties include background transparency or opacity and size.

Create a Blu-ray pop-up menu

1. Select **Menu > New Menu**, and select the new menu from the Project panel.
2. Select the **Pop-up** tab from the Properties panel, and select **Set As Blu-ray Pop-up Menu**.
3. Select the timeline that you want to associate with the pop-up menu.
4. On the Properties panel, select the menu you created from the **Set Popup Menu** list.
5. On the Project tab, select the menu you created.
6. On the Properties panel of the selected menu, select the timeline from the **Background Timeline pop-up menu**.

Add a video background to a menu

[To the top](#)

❖ Do one of the following:

- Select the menu in the Project panel. Then, in the Properties panel, click the **Motion** tab and drag the Video pick whip to the video file in the Project panel.
- Alt-drag (Windows) or Option-drag (Mac OS) the video file from the Project panel to the menu in the Menu Viewer.

Note: *You select a video asset, not a timeline, in the Project panel to replace the menu background with video.*

The first bright (nonblack) frame of the video replaces the menu background. This frame serves as a placeholder in the menu PSD file and is displayed in preview, unless you render the motion menus in the Preview panel. (See [About previews](#).) When you build the project, Encore renders the video starting from the first frame.

You can also set the menu background to the frame at the specified Loop Point timecode. This is useful when you want to align button subpicture layers with button images in the video background. (See [About menu display time and looping](#).)

Add audio to a menu

❖ Do one of the following:

- Select the menu in the Project panel. Then, in the Properties panel, click the Motion panel and drag the Audio pick whip to the audio file in the Project panel.
- Drag the audio file from the Project panel to the menu in the Menu Viewer.

Note: You link directly to the audio assets, not a timeline.

Create video thumbnail buttons

A button can contain a thumbnail image of the video to which it is linked. The image can be still or playing (animated). The Library panel includes predesigned video thumbnail buttons as well as menus with these buttons already in place.

Video thumbnail button restrictions

Understand the following concepts and restrictions when creating a video thumbnail:

Placeholder determines size You use a single layer in a button layer set to serve as a placeholder for the video. The size of the placeholder image determines the size of the video displayed in the menu. If the image is not rectangular, Encore calculates the smallest rectangle in which the image could fit.

Always rectangular, unless masked The video remains rectangular regardless of the shape of the image layer. However, you can overlay it with a layer (bitmap) or vector mask in Photoshop. A mask can hide portions of the image, forming a window through which the video plays.

Layer name prefix (%) The placeholder layer must have the layer name prefix (%). The prefix includes the parentheses, for example, (%)Rigging.

Destination timeline displayed A video thumbnail can display only the timeline to which it is linked, that is, its destination. You cannot play one timeline in the thumbnail and have the button lead to a different timeline. Also, until you link the button to the video, you see only the placeholder image.

Still or moving The thumbnail video can be still or moving. Animating video thumbnails is a menu setting. All the thumbnails on a particular menu must be either still or moving. You set the animation by using the menu property called Animate Buttons. (See Animate video thumbnail buttons.)

Looping or clipped A video thumbnail plays within the boundaries of the menu duration setting. If the menu duration exceeds the length of the video thumbnail, the thumbnail loops, starting at the destination chapter (or poster frame if specified). You set the menu display time and looping of the entire menu in the Properties panel. (See About menu display time and looping.)

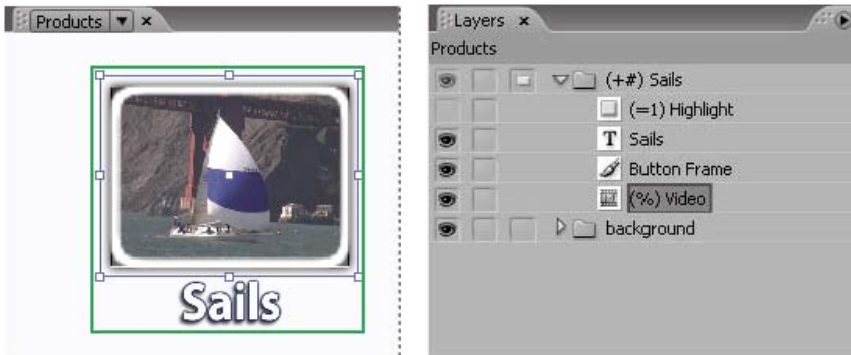

Poster frame Using the chapter property called Poster, you can designate a specific start point or frame to display. Otherwise, the thumbnail begins at the first frame of the destination chapter or displays the first bright (nonblack) frame of the chapter if Animate Buttons is turned off for the menu.



Video thumbnail button and corresponding button layers in Layers panel

Customize predesigned video thumbnail buttons

The easiest way to create a video thumbnail button is to drag a button from the Library panel into your menu and then edit the button. (Many menus in the Library panel already include video thumbnail buttons.) These predesigned buttons are sized appropriately and contain a placeholder image with the appropriate layer name prefix (%). These buttons also include predesigned button subpictures.

1. Open the menu to which you want to add video thumbnail buttons.
2. In the Library panel, click the Toggle Display Of Buttons icon  to display the predesigned buttons. Video thumbnail buttons have the word “video” in their names.
3. Drag the desired video thumbnail button from the Library panel to the Menu Viewer. Repeat until you have placed all the buttons you need.
4. To resize the video thumbnail buttons, select the button layer sets in the Layers panel (Shift-select to select more than one). Then, using the Selection tool , Shift-drag a corner selection handle of one of the buttons until they are the desired size. (Using the Shift key while dragging resizes the buttons proportionally so that they maintain their aspect ratio.)

5. Link each button to the appropriate item, such as a timeline or slide show. To rename the buttons without changing the text on the buttons, deselect Sync Button Text And Name in the Properties panel and select Set Name From Link. You can also use the Text tool to select and edit button text.

Create video thumbnail buttons in Photoshop

You can add a video thumbnail button to a menu in Photoshop and then bring the menu back into your project. The key is to size the placeholder appropriately for the video and to add the prefix (%) to the placeholder layer name.

1. Select the menu that you want to edit in the Project panel.
2. Choose Edit > Edit Menu In Photoshop, or click the Edit Menu In Photoshop tool  in the Tools panel.
3. Create a layer set (also called a layer group) and add (+) to the beginning of its name. Include the parentheses.
4. Create a placeholder for the video thumbnail within this layer set. You can draw the placeholder or place a still image. Do one of the following:

- Use a shape tool, such as the Rectangle tool, to create a mask for the video thumbnail. The shape of the layer becomes the mask.
- Create a layer, draw a selection with the Rectangular Marquee tool, fill the selection with a color, and then click the Add Layer Mask button in the Layers panel. The layer mask becomes the mask for the video thumbnail.

 You can constrain the rectangular marquee to the screen aspect ratio by using the Style option Fixed Aspect. Set the value for Width to 4 and for Height to 3 (or to 16 and 9 for widescreen video).

5. In the Layers panel, double-click the layer name of the placeholder image, and add (%) to the beginning of its name—for example, (%)Rigging Thumbnail.
6. Place any additional elements that you want in the button, such as text, within this layer set.
You can also add layer effects, such as drop shadows, glows, and transparency, to thumbnail layers in Photoshop.
7. Repeat steps 3 through 6 for any additional thumbnail buttons you want to create.
8. In Photoshop, choose File > Save, and then choose File > Close.
Photoshop saves the changes and updates the menu in Encore.

Set or change poster frames

[To the top](#)

Video thumbnails play the video of the timeline to which they are linked. If the thumbnails in the menu are still (the menu property Animate Buttons is deselected), they display the first bright (nonblack) frame of the destination link. You can change the start point or the still image displayed by a thumbnail by designating a poster frame. A poster frame is not limited to a chapter; you can place it on any frame in the timeline. If the button loops, it loops back to the poster frame rather than the destination chapter. (See About menu display time and looping.) The Poster option is a chapter property.

Set a poster frame

1. Open the timeline that is the destination for the video thumbnail button.
2. If the Monitor panel is hidden, choose Window > Monitor.
3. In the timeline, select the chapter marker that is closest to the destination for the video thumbnail button.
4. Move the current-time indicator to locate the exact frame you want displayed in the thumbnail.
5. Choose Timeline > Set Poster Frame.

A poster frame marker with its associated chapter number appears in the timeline. In addition, the timecode for the frame is added to the chapter properties in the Properties panel.

To create a moving video thumbnail, specify the poster frame, and then animate the button. (See Animate video thumbnail buttons.)

 You can also create a poster frame by Ctrl+Alt-dragging (Windows) or Command+Option-dragging (Mac OS) from the chapter marker in the timeline to the required frame.

Change a poster frame

1. Open the timeline containing the poster frame.
2. Drag the poster frame marker in the timeline. The Monitor panel displays the current location of the poster frame as you drag. When you release it, the Monitor panel again displays the location of the current-time indicator.

Delete a poster frame

1. Open the timeline containing the poster frame.
2. Drag the poster frame marker onto its corresponding chapter in the timeline.

[To the top](#)

Animate video thumbnail buttons

You can set video thumbnail buttons to be either still or moving using the menu property Animate Buttons. When you select the menu property, you convert all the video thumbnail buttons on the menu to motion buttons. Thus, each time the viewer displays the menu, the video links play in the thumbnails. When Animate Buttons is deselected, the thumbnails display a still frame of the video.

1. In the Project panel, select the menu containing the video thumbnail buttons.
2. In the Properties panel, click the Motion tab and select Animate Buttons.

The Animate Button property controls the state of all the video thumbnail buttons on the menu. You cannot set them individually. Encore composites the video into the button during the build process.

To preview the animated buttons, render the menu first. See [Preview motion menus](#) for information.

More Help topics



[Legal Notices](#) | [Online Privacy Policy](#)

Timelines and slide shows

Timeline basics

About timelines

Synchronize timelines with the asset's frame rate and dimensions

Timeline Viewer overview

Monitor panel overview

[To the top](#)

About timelines

Your projects can contain multiple features, such as movies and a slide show. For example, a wedding DVD might have separate videos of the bride and groom getting ready, the ceremony, and highlights of the reception, along with a slide show of wedding photos. You arrange the necessary assets of each feature—video clips or still images, the main audio, and possibly supplemental audio and subtitles—into timelines, graphic representations of a feature over time. You can create a slide show by adding still images to a timeline, but the Slideshow Viewer offers more options. (See [About slide shows](#).)

Depending on its complexity, your project may consist of a single timeline or several timelines. You can place multiple video clips, audio clips, and still images in a single timeline, or you can place these items in separate timelines. Each timeline contains tracks for the assets of a feature. Video, audio, and subtitles all appear on separate tracks.

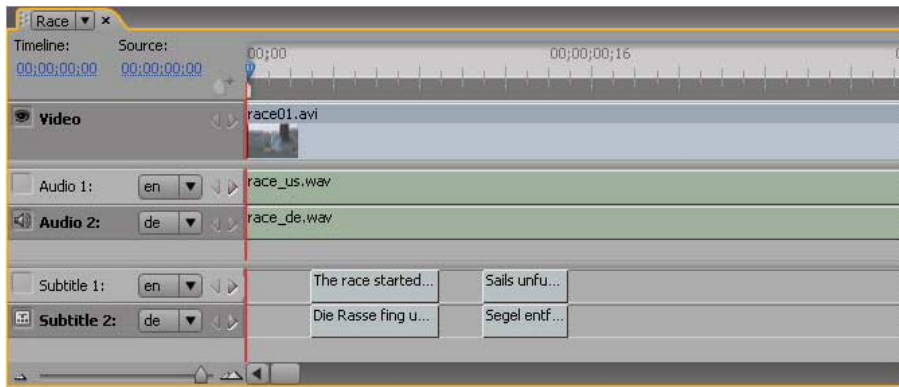

This timeline includes a video track, two audio tracks, and two subtitle tracks.

You can link to a timeline from a menu. The timeline shows you the duration of each asset and its placement in time relative to the other assets. You can mark specific locations in the feature by using chapter points, and position subtitles to match the video or still images. For a video tutorial on working with timelines, see www.adobe.com/go/lrvid4229_enc.

[To the top](#)

Synchronize timelines with the asset's frame rate and dimensions

When you import assets with different frame rates and dimensions, Encore creates timelines that are synchronized with the asset's properties. The original frame rate of the assets is retained during transcoding resulting in a higher quality Blu-ray output.

Because all assets are placed in timelines which are synchronized with the asset's frame rate and dimensions, playback occurs in real time. Real-time playback enhances the quality of the playback, and provides for more accurate positioning of subtitles.

You can also place assets with different frame rates or dimensions in a single timeline. In such cases, the timeline takes the frame rate and dimensions of the first asset if the first asset is set Auto Transcode. On the other hand, transcode settings of the first asset that have been manually set are applied to all assets in the timeline.

For example, the transcode settings of the first asset is applied to all assets if all assets in the timeline use automatic transcode settings. However, if the transcode settings of the third asset in the timeline is changed manually, the entire timeline inherits the transcode settings of this asset.

Encore allows you to use the same asset in multiple timelines that can have different frame rates or dimensions. In such cases, Encore transcodes these assets for each timeline with the frame rate and dimensions of the timeline in which it is placed. The Properties panel displays the transcoding status for each timeline.

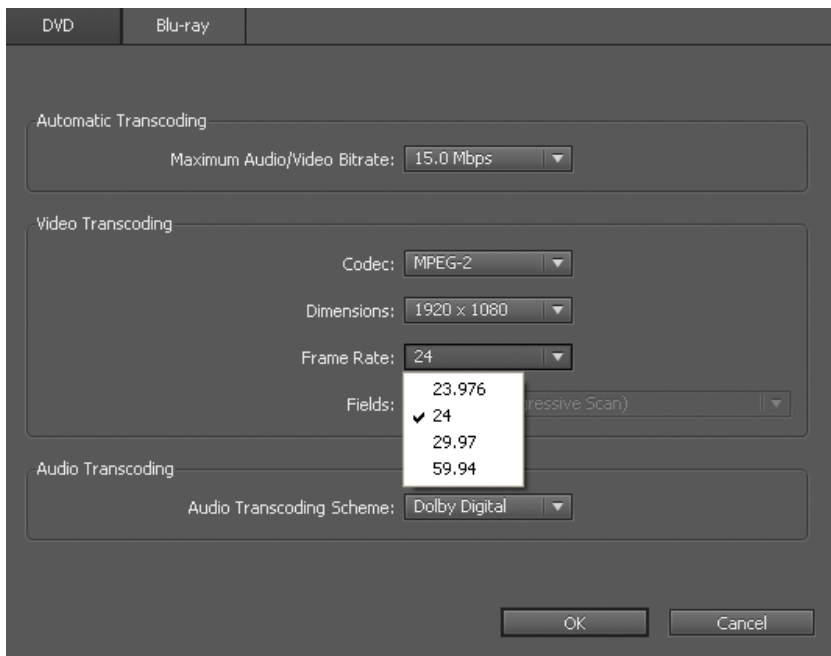

Timeline Viewer overview

[To the top](#)

A Timeline Viewer displays all of the components of a timeline, including its time ruler, a video track, and optional tracks for audio and subtitles. The time scale used in the ruler depends on the editing timebase of the project: for example, 29.97 fps for NTSC media and 25 fps for PAL media. You place the assets and subtitles on the tracks below the ruler.

Depending on how the Appearance preferences are set, timelines can be displayed in separate viewers (click on their tabs to select them), and they can be grouped together in a single viewer, and you select them from the tab's pop-up menu.

Note: All timelines in a project are written to disc, even if they aren't linked to anything. Make sure to delete any orphaned (unlinked) timelines you do not want to use.

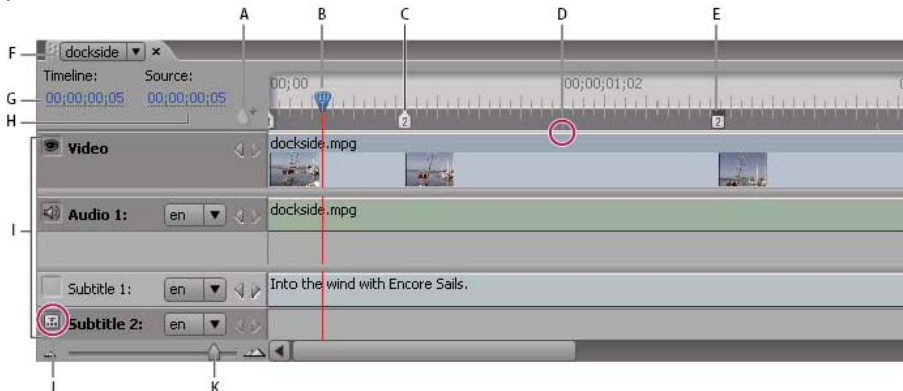

A Timeline Viewer

A. Add Chapter button **B.** Current-time indicator **C.** Chapter point **D.** GOP header **E.** Poster frame **F.** Timeline tab displaying current timeline **G.** Current timecode in timeline **H.** Current position in source clip **I.** Tracks **J.** Track selector **K.** Zoom slider

A Timeline Viewer includes the following elements:

Add Chapter button Adds a chapter point at the current-time indicator.

Current-time indicator Indicates the current edit point in the timeline. This location is reflected by the frame displayed in the Monitor panel. Similar to a cursor in text or the playback head on a video player, the current-time indicator points to the current location in the clip and determines the timecode display.

Chapter point Marks a chapter point within the video. Chapter points are useful for jumping to scenes in the content and can be linked from menus, buttons, and other timelines. (See [Add chapter points](#).)

GOP header Indicates the location of a GOP (group of pictures) header in an MPEG-2 video. GOP headers are displayed as gray vertical lines along the bottom edge of the ruler. They are visible only if you've zoomed in sufficiently. If you've added an AVI or MOV file, you will not see GOP headers until the timeline is transcoded. (See [About chapter points](#).)

Poster frame Marks the frame to display in a video thumbnail button. (See [Create video thumbnail buttons](#).)

Timeline tab Lets you determine which timeline to display in the viewer by either clicking individual tabs or by selecting a timeline name from a tab menu (depending on your User Interface preferences for the Timeline Viewer). See [Set preferences for workspace](#).

Timeline timecode Specifies the location of the current-time indicator within the timeline. The format of the timecode uses semicolons

(hours;minutes;seconds;frames) for NTSC projects and colons (hours:minutes:seconds:frames) for PAL projects. You can edit the timecode to set the current time in the timeline.

Source timecode Specifies the location of the current-time indicator within the video clip (using the video clip's timecode).

Tracks Display the names of video, audio, and subtitle clips and show their locations in the timeline. Video, audio, and subtitles are displayed on separate tracks.

Track selectors Designate the active track—the track played when you view the timeline in the Monitor panel. You can activate only one audio and one subtitle track at a time. However, whereas one audio track must be active (even if it is empty), you do not need to activate a subtitle track.

Zoom slider and buttons Zooms in and out on the timeline.

Note: You can also press the + (plus) key to zoom in and the - (minus) key to zoom out. For more keyboard shortcuts, see [Using keyboard shortcuts](#).

Previous and Next buttons Moves the current-time indicator to the previous ◀ or next ▶ video clip, audio clip, still image, or subtitle clip and selects it in the timeline.

Monitor panel overview

[To the top](#)

The Monitor panel lets you view and play the content of the current timeline or slide show, as well as add and edit subtitles and chapter points. It displays the frame marked by the timeline's current-time indicator and can play all or portions of the timeline. If the selected timeline contains multiple audio or subtitle tracks, you determine which track to play by activating the track using the track selector.



Monitor panel

A. Zoom Level **B.** Show Safe Area **C.** Subtitle controls **D.** Playback controls **E.** Chapter controls

The Monitor panel includes the following controls:

Previous Subtitle Moves back to the first frame of the previous subtitle.

Next Subtitle ⇄ Moves forward to the first frame of the next subtitle.

Trim Subtitle In-Point To Here ⏪ Trims the subtitle so that it starts on the current frame.

Trim Subtitle Out-Point To Here ⏩ Trims the subtitle so that it ends on the current frame.

Add Subtitle ⏶+ Adds a subtitle with the same format as the previous subtitle.

Timecode Displays the timecode of the currently displayed frame. You can change the timecode by selecting it and typing new digits or by dragging the pointer to the left or right inside it.

Step Backward ◀ Moves back one frame. To skip back to the closest GOP header in a MPEG-2 video, Alt-click (Windows) or Option-click (Mac OS) the button.

Play and Pause buttons Plays ▶ or pauses || the currently active video, audio, and subtitle track. (Active tracks have an icon in the track selector box next to the track name.)

Step Forward ▶ Moves forward one frame. To skip forward to the next GOP header in a MPEG-2 video, Alt-click (Windows) or Option-click (Mac OS) the button.

Previous Chapter ⏪+ Skips back to the previous chapter.

Next Chapter ⏩+ Skips forward to the next chapter.

Add Chapter ⏶+ Adds a chapter at the currently displayed frame or, with MPEG-2 video, at the closest GOP header prior to the currently displayed frame.

Zoom Level Increases or decreases the magnification of the image in the Monitor panel by the specified percentage. If Fit is selected, the video frame is scaled to match the size of the monitor panel's boundaries.

Note: You can also press the + (plus) key to zoom in and the - (minus) key to zoom out. For more keyboard shortcuts, see [Using keyboard shortcuts](#).

Show Safe Area  Displays the action safe areas and title safe areas. Keep subtitles within the boundaries of the inner guides to avoid clipping on some monitors. (Television monitors reduce the visible area of footage and menus. The actual amount that is clipped varies from monitor to monitor.)

[More Help topics](#)

[Create and manage timelines](#)



[Legal Notices](#) | [Online Privacy Policy](#)

Create and manage timelines

[Create a timeline](#)

[Add videos or still images to timelines](#)

[Preview timelines](#)

[Move around in timelines](#)

[Zoom in and out of timelines](#)

Create a timeline

[To the top](#)

You can create new blank timelines and add assets to them or create new timelines based on a selected asset in the Project panel.

- To create a new timeline, do one of the following:
 - Choose Timeline > New Timeline or choose File > New > Timeline. A blank timeline is created, ready for you to add assets.
 - Right-click (Windows) or Control-click (Mac OS) the video, audio, or still image asset in the Project panel, and choose New > Timeline. Encore opens the Timeline Viewer and creates a new timeline with the asset already placed on the appropriate track.
 - Click the Create A New Item button at the bottom of the Project panel and choose Timeline from the pop-up menu.

 *To place a video and an audio file together in the same timeline, select both files in the Project panel and click the New Timeline button. (Other types of assets, when selected together, will create separate timelines for each type.)*

Add videos or still images to timelines

[To the top](#)

When you add a video or still image asset to an existing timeline, Encore positions it as a new clip at the end of the track adjacent to the last clip and automatically adds a chapter point at the beginning of the new clip. You can reposition the clip and its chapter point as needed.

Note: *When a single audio clip is used for multiple video clips, a hiccup in the audio occurs when the movie moves from one video clip to another.*

Add a video clip to a timeline

1. In the Project panel, do one of the following:
 - a. Right-click (Windows) or Control-click (Mac OS) the video, and choose New > Timeline. Encore opens the Timeline Viewer and creates a new timeline with the video already placed on the video track.
 - b. Choose Timeline > New Timeline and drag the video from the Project panel to the video track of the new timeline. Encore positions a video clip at the beginning of the timeline, regardless of where in the timeline you release the mouse.
 - c. Select the video and press Ctrl-T (Windows) or Command-T (Mac OS).
2. To add additional video clips to the timeline, drag the video from the Project panel to the video track.

Add a still image to a timeline

You can add still images to a timeline that includes one or more movie clips, or you can add a series of still images to a timeline to create a slide show effect. However, to create a slide show, you may want to use the Slideshow Viewer. (See About slide shows.)

1. Select the still image in the Project panel, and choose Timeline > New Timeline.
2. Drag any additional still images from the Project panel to the video track.
3. If the Edit Still Duration dialog box appears, enter the number of seconds you want the still image to be displayed. (To prevent this dialog box from appearing again, select Don't Show Again.) Click OK.

Encore creates a new timeline with the still image placed at the beginning of the video track.

[To the top](#)

Preview timelines

You can preview the contents of the current timeline in the Monitor panel. You can add chapters, type subtitles, and edit the In points and Out points of the subtitles. To preview your entire project and check the links, use the Project Preview window. (See [Preview a project](#).)

Note: *Encore writes all timelines in a project to disc. Make sure that you delete the timeline if you decide not to use it in your current project. Timelines that are not linked to menus are still accessible if the viewer uses the title search feature available on some players. Use [Check Project](#) to locate orphaned (unlinked) timelines.*

1. Open the timeline you want to view (or select it from the Timeline tab if it is already open).
2. If the Monitor panel is hidden, choose Window > Monitor.
3. Position the current-time indicator at the location where you want to begin.
4. Click the Track Selector (next to the track name) to activate the audio and subtitle tracks you want to play.
5. Click the Play button ▶ to begin viewing the timeline.
6. Click the Pause button || to pause the timeline.

[To the top](#)

Move around in timelines

The Timeline Viewer and Monitor panel work in tandem. The Monitor panel displays the frame at the location of the current-time indicator in the timeline. When you change your location in one, the other panel changes as well. The Timeline Viewer and Monitor panel give you several shortcuts to move to another frame. Besides simply dragging the current-time indicator in the ruler, you can skip forward or back to the next subtitle, GOP header, or chapter point, as well as specify a location using the timecode.

Move to a specific location in the timeline

Do one of the following:

- Drag the current-time indicator to a new location on the time ruler.
- Click a new location on the time ruler.
- Press the Right Arrow or Left Arrow key to move the current-time indicator one frame in either direction.

Move to the next or previous clip or edit point

Do one of the following:

- To move to the next clip, click the Next Clip button ▶ on the appropriate track.
- To move to the previous clip, click the Previous Clip button ◀ on the appropriate track.
- To move forward to the next edit point (end of clip or next chapter point), press the Page Down key.
- To move back to the previous edit point (start of clip or previous chapter point), press the Page Up key. Press Home or End to move to the beginning or end of a track.
- To move to the beginning or end of a track, press Home or End.

Move to next subtitle or chapter point

Do one of the following:

- To move to the next subtitle of the active subtitle track, click the Next Subtitle button ▶⌂ in the Monitor panel.
- To move to the previous subtitle of the active subtitle track, click the Previous Subtitle button ⌂◀ in the Monitor panel.
- To move to the next chapter point, click the Next Chapter button ▶↓ in the Monitor panel.
- To move to the previous chapter point, click the Previous Chapter button ↓◀ in the Monitor panel.

Move to the next or previous GOP header

Do one of the following:

- To move to the next GOP header in MPEG-2 video, Alt-click (Windows) or Option-click (Mac OS) the Step Forward button **▶** in the Monitor panel.
- To move to the previous GOP header in MPEG-2 video, Alt-click (Windows) or Option-click (Mac OS) the Step Backward button **◀** in the Monitor panel.

Move the current-time indicator using the timecode

You can edit the eight-digit timecode in the Timeline Viewer to change the position of the current-time indicator.

Do one of the following in the Timeline Viewer:

- Position the Selection tool over the timecode value and drag to the left or right. The timecode increases (to the right) or decreases (to the left), the current-time indicator moves, and the Monitor panel updates. The farther you drag, the more quickly the timecode changes.
- Click the timecode value, type a new time, and press Enter. Use any of the timecode shortcuts listed below.

Timecode shortcuts

Use any of the following shortcuts to enter a timecode that moves the current-time indicator in the timeline:

Omit leading zeros For example, entering 0;0;12;3 becomes 00;00;12;03 in an NTSC project.

Omit semicolons (;) for NTSC or colons (:) for PAL For example, 1213 becomes 00;00;12;13 for NTSC projects and 00:00:12:13 for PAL projects.

Include a plus sign (+) or minus sign (-) A plus sign or minus sign before a specified number moves the current-time indicator ahead or back that number of frames. For example, +55 moves the current-time indicator ahead 55 frames.



Add a period A period before a number specifies an exact frame number rather than its timecode value. For example, .1213 moves the current-time indicator to 00;00;40;13 in an NTSC project, and to 00:00:48:13 in a PAL project.

Zoom in and out of timelines

[To the top](#)

When zoomed in fully, each tick mark on the time ruler represents a frame. As you zoom out, you can see more of the complete timeline, and the tick marks represent larger increments.

Do one of the following:

- Click the Zoom In icon  or drag the zoom slider to the right. The timeline expands to show more detail.
- Click the Zoom Out icon  or drag the zoom slider to the left. The timeline contracts to show less detail.
- Select the Zoom tool  from the Tools panel and click or drag over the area of the timeline you want to expand; you can also Alt-click (Windows) or Option-click (Mac OS) to contract the timeline.
- Press the plus sign (+) or minus sign (-) key to zoom in or out.
- Press the backslash key (\) to fit the entire timeline in the viewer.

 Twitter™ and Facebook posts are not covered under the terms of Creative Commons.

[Legal Notices](#) | [Online Privacy Policy](#)

Editing assets in timelines

- [View the properties of a clip](#)
- [Trim video and audio clips in timelines](#)
- [Delete video or audio clips from timelines](#)
- [Move clips in timelines](#)
- [Edit clips in Adobe Premiere Pro and Adobe After Effects](#)
- [Change the display time of still images](#)
- [Scale and crop still images](#)
- [Save frames as still images](#)

View the properties of a clip

[To the top](#)

Once you add an asset to a timeline, it becomes a clip (video, audio, subtitle, or still-image clip), and the Properties panel displays the relevant information about it. You can use an asset multiple times in a project. Although the asset itself appears only once in the Project panel, each occurrence in a timeline is a unique clip with its own properties.

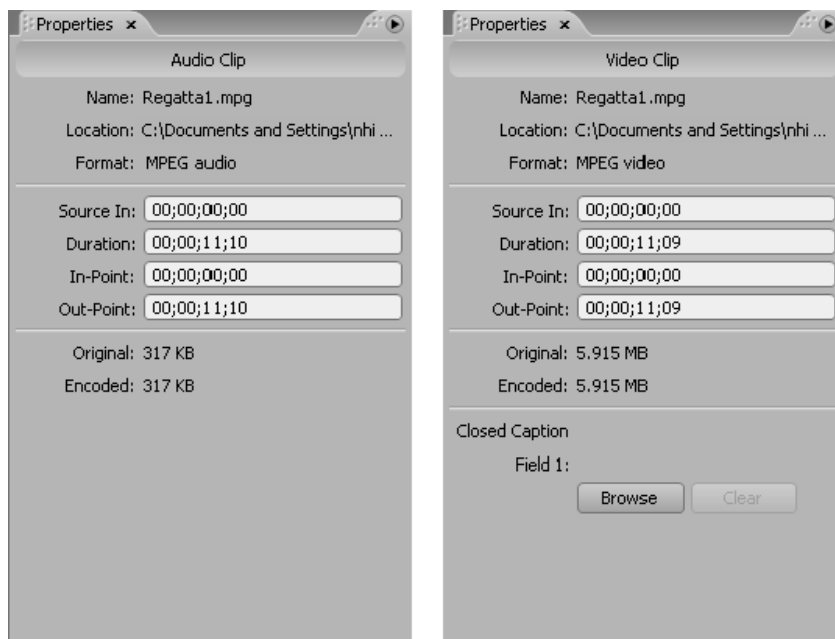

Audio and video properties in Properties panel

❖ Select the clip in the timeline. Encore displays the clip properties in the Properties panel.

Note: The Encoded option shows the size of the clip after transcoding or the estimated size if not yet transcoded.

Trim video and audio clips in timelines

[To the top](#)

You can trim video and audio clips directly in the timeline or by editing the Duration timecode in the Properties panel. You can trim the In point or Out point of a clip, but if you need to remove a section from the middle of a clip or make more advanced edits, use the Edit Original command to edit the clip in Adobe Premiere Pro or Adobe After Effects.

1. Open the timeline containing the video or audio clip you want to trim (or click its tab in the Timeline Viewer if it is already open).
2. Do one of the following:
 - Position the Direct Select tool pointer over the end of the clip that you want to trim. The pointer changes to a red bracket. Drag the end of the clip to the desired location to increase or decrease its length.

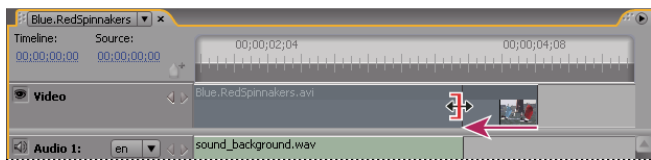

Trimming a video clip

- In the Properties panel, select the Duration timecode and type a new timecode to shorten or lengthen the clip.

Delete video or audio clips from timelines

[To the top](#)

The method you use to delete a video or audio clip determines whether subsequent clips remain in place or shift to the left to fill in the gap.

1. Open the timeline containing the clip you want to delete.
2. Click one of the selection tools, and select the clip you want to delete.
3. Do any of the following:
 - To clear a clip from a track, choose Edit > Clear. Any other clip on the track remains in place.
 - To ripple delete a clip, choose Edit > Ripple Delete. The selected clip is removed, and additional clips shift to the left to fill its gap. (You can also press Shift+Delete.)

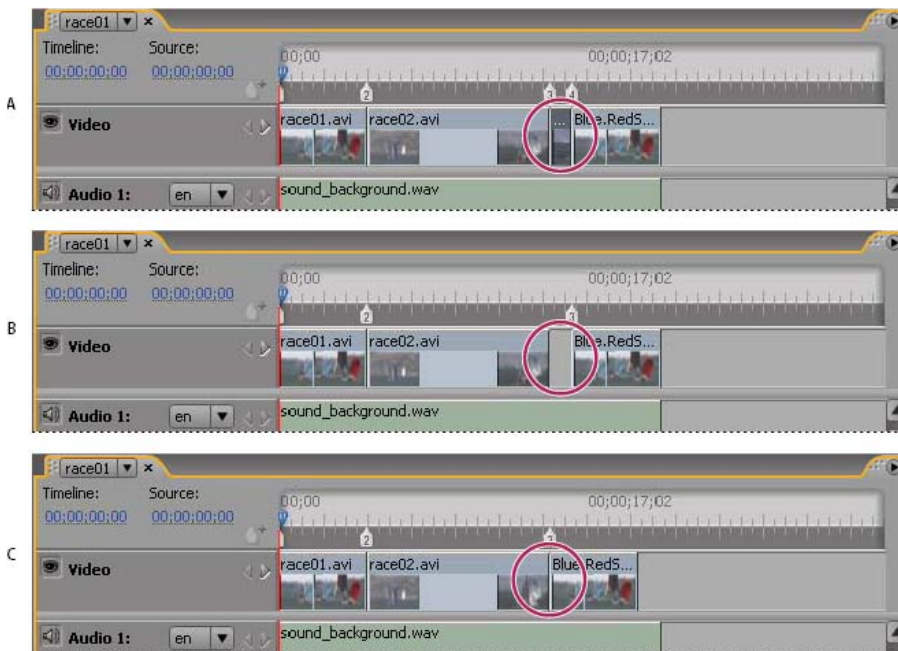

Difference between clearing and ripple deleting clips

A. Middle clip selected B. Clip cleared C. Clip ripple deleted

Note: Ripple deleting can cause audio and subtitle clips to go out of sync with video clips.

Deleting a video or audio clip removes the item from the timeline, but the item is not deleted from the Project panel. To remove an entire audio or subtitle track rather than just a clip, see Remove audio or subtitle tracks.

To delete clips, you can also right-click (Windows) or Control-click (Mac OS) a clip and choose an option from the context menu.

Move clips in timelines

[To the top](#)

You can easily change the position of clips in a timeline.

Move a clip in a timeline

Do one of the following:

- In the Timeline Viewer, drag the clip to the desired location.
- In the Properties panel, select the In-Point timecode and type a new timecode.

Move audio separately from video portion of a clip

1. Select the Selection tool in the Tools panel.

2. Hold down the Alt key (Windows) or Option key (Mac OS) and drag the video portion or the audio portion of the clip.

Note: This keyboard shortcut now matches the keyboard shortcut for slipping audio or video independently in Adobe Premiere Pro.

Edit clips in Adobe Premiere Pro and Adobe After Effects

[To the top](#)

The Edit Original command lets you edit video in Adobe Premiere Pro and After Effects without leaving your project. Once you export the video from Adobe Premiere Pro or After Effects, your edits are automatically updated in any timeline containing the video. This command works only for assets that have been created in Adobe Premiere Pro or After Effects and have a project link embedded within them. (See [Basics of exporting](#) in Adobe Premiere Pro Help or [Output modules and output module settings](#) in After Effects Help.)

1. In the Project panel, select the video file (not the timeline) you want to edit.
2. Choose Edit > Edit Original.
Adobe Premiere Pro or After Effects (depending upon which is pointed to in the project link) starts and opens the video project.
Note: If Edit Original is dimmed, the video may not contain a project link.
3. Make changes as necessary.
4. Export the file to the same name, file format (MPEG-2, AVI, or MOV), and location as the original file, overwriting it.

Change the display time of still images

[To the top](#)

Although the Slideshow panel is the preferred method for creating a slide show, you can also add still images to a timeline to create a slide show. The default timeline duration for a still image is 6 seconds. You can increase or decrease the duration of any still image after you place it, or you can change the default duration before you place it.

Change the duration of a still image

1. Open the timeline containing the still image you want to change.
2. Position the Selection tool pointer over the end of the still image that you want to adjust. The pointer changes to a red bracket with a double-sided arrow.
3. Drag the end of the clip to increase or decrease its length.

Note: To increase the length of a still image, there must be empty frames adjacent to it.

Change the default duration of still images

1. Choose Edit > Preferences > Timelines (Windows) or Encore > Preferences > Timelines (Mac OS).
2. For Still Image Duration, type the number of seconds you want still images to display, and click OK.

Encore changes the display time of all subsequently placed still images. Existing still images remain unchanged.

Scale and crop still images

[To the top](#)

When you place a still image into a timeline, Encore proportionally scales it up or down to fit the entire image into the frame, placing a black matte over any unfilled areas. (You can tell if an image doesn't match the project frame size if you see a black matte in the preview thumbnail in the Project panel.) You can use the Scale options in the Properties panel either to turn off scaling or to fill the frame and crop the image.

1. Open the timeline and select the image or images you want to scale.
2. In the Properties panel, select a Scale option:

Do Nothing Maintains the original dimensions of the image. The image is centered. Any portion of the image that exceeds the frame is cropped. Unfilled areas of the frame are matted in black.

Scale And Apply Matte Proportionally scales the image up or down so that the entire image fits the frame, applying a matte as necessary to fill any blank area of the frame.

Scale And Crop Edges Proportionally scales the image up or down until it fills the frame, cropping any area that exceeds the frame.

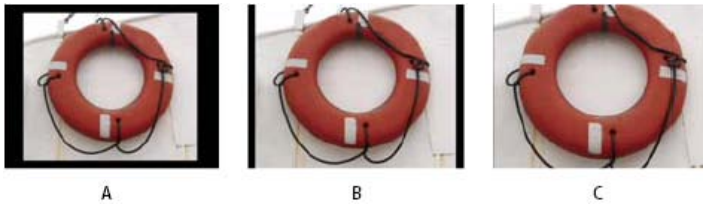

Comparison of the three Scale options

A. Do Nothing **B.** Scale And Apply Matte (default) **C.** Scale And Crop Edges

Note: Encore scales or crops the image as a clip in the timeline. It does not affect the original clip in the project or on your hard drive. Each instance of the image in a timeline can have different scale settings.

Save frames as still images

[To the top](#)

When you save a frame as a still image, Encore exports the still image as a Photoshop file (.psd).

1. Navigate to the frame you want to save as a still image in either the Timeline Viewer or the Monitor panel.
2. Choose Timeline > Save Frame As File.

Note: The Timeline Viewer or the Monitor panel must be selected for this command to be available.

3. Enter a name and location for the file in the Save Frame As File dialog box that appears, and then click Save.

More Help topics

[Create and manage timelines](#)

[Importing from Adobe Premiere Pro](#)

[About slide shows](#)



[Legal Notices](#) | [Online Privacy Policy](#)

Chapter points

[About chapter points](#)

[Add chapter points](#)

[Delete chapter points](#)

[Move chapter points](#)

[Name and describe chapter points](#)

[Display chapter names in the time ruler](#)

About chapter points

[To the top](#)

You add chapter points to mark a specific frame of a video clip in a timeline. Chapter points commonly mark the beginning of specific scenes and sequences. Chapter points also let the viewer skip forward or back through a clip by pressing the Next Chapter or Previous Chapter buttons on the remote control. You can link to chapter points, add actions to chapter points, or use them to place subtitles.

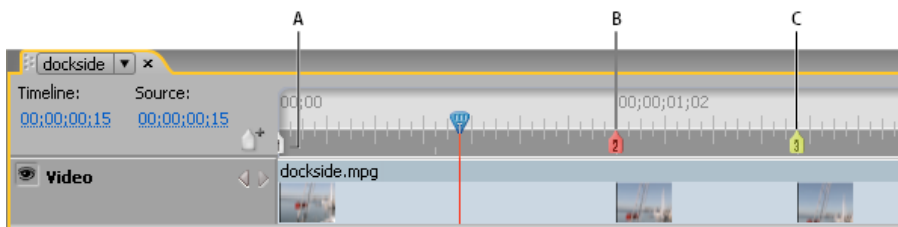

Add chapter points as needed for linking to scenes or identifying locations for subtitles.

A. Chapter 1 inserted automatically **B.** Currently selected chapter point is red **C.** Green chapter point indicates end action is assigned to it

Note: For interactive Flash projects, timelines use separate media, so there is a pause between chapters, similar to a pause between layers on a DVD.

As part of transcoding to the MPEG-2 compression scheme for DVD projects, video footage is divided into contiguous groups of pictures (GOPs), which range from 4 to 20 frames per group. Playback of any frames within the GOP must begin from the start of the GOP, the GOP header. For this reason, when you insert a chapter point, Encore places it at the closest GOP header prior to the current frame. If a chapter point already exists at the prior GOP header, the program places it at the next GOP header. The time ruler displays GOP headers as gray vertical lines along the bottom edge of the ruler. The Monitor panel lets you skip forward or back to the next GOP header.

When you work with AVI or MOV files, these restrictions do not apply until you transcode the clips for DVD projects. When Encore transcodes the AVI or MOV files, it automatically sets GOP headers at every chapter point you set. After transcoding, the file is considered an MPEG-2 file, and the rules for chapter point placement for MPEG-2 files apply to that clip. The minimum allowed distance between chapter points is 15 frames for NTSC and 12 frames for PAL.

Note: These restrictions do not apply for H.264 Blu-ray files.

Add chapter points

[To the top](#)

You can add chapter points from both the Monitor panel and the Timeline Viewer. Chapter points are numbered sequentially and renumbered automatically if you insert a new point between two existing chapters. You can also add chapter points at set intervals.

When you place video or still images, Encore automatically inserts a chapter point at the beginning of a clip. Encore also adds an invisible chapter at the end of timelines to use for linking to end actions.

Note: Adobe Premiere Pro and After Effects can export markers in AVI, MOV, MPEG-2, and H.264-Blu-ray files. Encore uses the markers to create chapter points. (See [Importing from Adobe Premiere Pro](#) and [Importing from Adobe After Effects](#).)

Add chapter points at specific locations

1. Open the timeline to which you want to add chapter points.
2. Choose Window > Monitor to view the video as you add chapter points.
3. Move the current-time indicator to the frame where you want a chapter point.
4. If you are working with MPEG-2 or other video that you have already transcoded for DVD, Alt-click (Windows) or Option-click (Mac OS) either the Step Forward button or the Step Backward button ◀ in the Monitor panel to see the next GOP header. Remember that chapter points only land on GOP headers in DVD-transcoded video. (See About chapter points.)
5. Choose Timeline > Add Chapter Point, or click the Add Chapter button  in the Monitor panel or Timeline Viewer.

 You can also add chapter points while the timeline plays. Press the asterisk (*) key to add a chapter point.

Add chapter points at set intervals

1. Open the timeline to which you want to add chapter points.
2. Choose Timeline > Add Chapter Points At Intervals.
3. Specify the interval at which to add chapter points. The interval value must be lower than the timeline duration.
4. Indicate whether you want to remove existing chapter points, and then click OK.

Delete chapter points

[To the top](#)

1. Open the timeline containing the chapter point or points you want to delete.
2. Click to select the chapter point you want to delete, or Shift-click to select multiple chapter points.
3. Do one of the following:
 - Press the Backspace or Delete key.
 - Right-click (Windows) or Control-click (Mac OS) and choose Delete Chapter Point from the context menu.

Move chapter points

[To the top](#)

1. Open the timeline containing the chapter points you want to move.
2. Drag the chapter point or group of chapter points to the desired location in the ruler.

The Monitor panel updates to display the chapter point's new position.

Note: You cannot move the first chapter point, which marks the beginning of the timeline.

Name and describe chapter points

[To the top](#)

1. Select the desired chapter point in either the Timeline Viewer or the Timelines panel.
2. In the Properties panel, type a new name for the chapter point.
3. Enter any notes about the chapter point for Description.

Display chapter names in the time ruler

[To the top](#)

1. Open the desired timeline.
2. Choose View > Show Chapter Names.

Note: This view setting applies only to the current timeline.



[Legal Notices](#) | [Online Privacy Policy](#)

Slide show basics

- [About slide shows](#)
- [Create slide shows](#)
- [Creating slideshows](#)
- [Preview a slide show](#)
- [Render a slide show](#)
- [Editing slide shows](#)

About slide shows

[To the top](#)

A slide show contains a set of still images that viewers can play in a sequence. After you create a slide show, use the Slideshow Viewer to add still images. Supported file types include BMP, GIF, JPEG, PNG, PSD, PICT, and TIFF. In the Slideshow Viewer, you can also reorder slides, add and reorder audio clips, determine the duration of the slides, and change other settings.

You can have more than 99 slides in a slideshow for DVD. Encore accommodates any additional slide you add beyond 99 slides in the last chapter. You can add up to 999 slides in a slideshow for Blu-ray.

Encore accommodates any additional slide beyond 999 slides in the last chapter. However, you cannot use Manual Advance on your remote for individual slides in the last chapter.

However, Encore does not impose any such limitation on the number of slides you can add to a slideshow for web DVDs.

Note: Adobe recommends that for optimum performance, you add no more than 200 slides in a slideshow. Including additional slides beyond 200 may impact the performance of the software.

Use the Properties panel to change settings for the entire slide show or for individual slides you select. After you add slides to the slide show and change the appropriate settings, set a link to the slide show from a menu button or other item. For a video tutorial on creating slide shows, see www.adobe.com/go/lrvid4230_enc.

 Choose **Window > Workspace > Slideshow Design** to arrange all the necessary panels for working with slides.

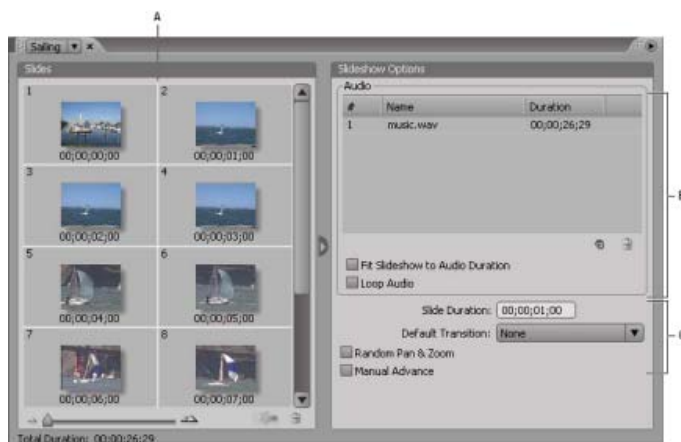

Slideshow Viewer

A. Slides area B. Audio area C. Slideshow options

Create slide shows

[To the top](#)

1. Do one of the following:

- To create a slide show from assets in the Project panel, select the still images and audio clips, right-click (Windows) or Control-click (Mac OS) the selection, and choose **New > Slideshow**. Still images appear in the Slides area, and audio clips appear in the Audio area of the Slideshow Viewer. The name of the slide show is based on the first asset you selected.
- To create a blank slide show, make sure that nothing is selected in the project, and choose **Timeline > New Slideshow**, or choose **File > New > Slideshow**. A new slide show appears in the Slideshow Viewer named "Untitled Slideshow."

- To import multiple images into a slide show, choose File > Import As > Slideshow, select the images, and then choose Open.
2. In the Properties panel, type the name of the slide show, and type a description.
 3. Add images by dragging them from the Project panel to the Slides area in the Slideshow Viewer. To select multiple images to drag, Shift-click them.

 To expand the Slides area, click the Hide button on the right side of the Slides area to hide Slideshow Options. Click the Show button to view the options again.

As you add images to a slide show, they are automatically scaled to fit the project dimensions. You can use the Properties panel to change scaling options of individual slides.

4. Do any of the following:
 - Drag the slides in the Slides area to change their order. Use the slider in the lower-left corner of the Slideshow Viewer to zoom in and out. You can also press the + (plus) key to zoom in and the - (minus) key to zoom out.
 - Set the slide show audio and duration. (See [Add audio to slide shows.](#))
 - Delete a slide by selecting it and pressing Delete. This removes the slide from the slide show, but it does not remove the image from the Project panel.
 - Adjust the properties of the slide show and individual slides. (See [Changing individual slide settings.](#))

***note:** It isn't necessary to use the Slideshow Viewer to create slide shows. You can instead create a slide show manually by adding still images to a timeline. Although this method lets you combine slides with movie clips, you can't add transitions or change other options available in the Slideshow Viewer. (See [Add videos or still images to timelines.](#))*

Preview a slide show

[To the top](#)

- With the Slideshow Viewer selected, click the Play button in the Monitor panel.

The slide show previews from the currently selected slide, or from the beginning of the slide show if no slides are selected. You can also choose File > Preview to preview the entire project.

 Rendering a slide show lets you preview it at a higher quality.

Render a slide show

[To the top](#)

Rendering a slide show lets you preview it at a higher quality.

- Choose File > Render > Slideshows.

Editing slide shows

[To the top](#)

Changing individual slide settings

The options in the Slideshow Viewer and Properties panel affect all slides in the slide show, as long as no individual slides are selected. By selecting one or more slides in the Slideshow Viewer, the options you change in the Slideshow Viewer or Properties panel affect only the selected slides. This gives you the flexibility to set a default transition for all slides in the slide show and then set a different transition for a special slide, for example.

When editing individual slides, use the Basic pane of the Properties panel to change the name and description, specify the duration, set scaling options, and create subtitles. Use the Transitions pane to specify a different transition for the slide. Use the Effects pane to specify pan and zoom settings for the slide.

Add audio to slide shows

If you want sound to play during the slide show, you can add one or more audio clips to the Audio area of the Slideshow Viewer. Only audio files may be added to the Audio area. Supported audio file formats include WAV, AC3, MPEG (layer II), and AIFF.



The audio files are played in order during the slide show.

1. Create a slide show, and import one or more audio clips as assets in the Project panel.
2. Drag the audio assets from the Project panel to the Audio area of the Slideshow Viewer.
3. If necessary, adjust the order in which the audio files are played by dragging them elsewhere in the list.
4. Under the Audio area, select one of the following:

Fit Slideshow To Audio Duration Adjusts the length of each slide in the slide show equally, based on the total duration of the audio file or files specified, ensuring that both the audio and slides finish at the same time. This option overrides the individual slide duration settings.

Loop Audio Continues playing the audio clip or clips until the slide show ends. This is especially useful if the slide duration exceeds the duration of the audio clips.

Set slide transitions

You can apply a default transition to all slides in a slide show or to individual slides. You can customize many of the transition types you select using the Transition pane in the Properties panel.

1. Do any of the following:
 - To apply a transition to the entire slide show, deselect all slides and, in the Slideshow Viewer, select a transition other than None from the Default Transition menu.
 - To set a transition for individual slides, select one or more slides in the Slideshow Viewer, and choose the transition in the Transition pane of the Properties panel. If you want a slide to use the same transition as the slide show, select Match Slideshow.
2. Specify the duration of the transition.
3. Specify additional options, if any, that appear in the Transition pane of the Properties panel. For example, if you selected the Wipe transition, you can specify the direction of the wipe and the border width and color.

Apply a pan and zoom effect to slides

The pan and zoom effect provides a sense of motion to still images. *Panning* refers to moving across the image, and *zooming* refers to changing the image's magnification. A pan and zoom effect is often used in documentaries to make pictures appear more dynamic.

- To apply a random pan and zoom effect to all slides in the slide show, select Random Pan & Zoom in the Slideshow Viewer. Encore randomly assigns a pan and zoom setting to each slide. You can keep the settings as assigned or modify them for individual slides in the Properties panel.
- To apply pan and zoom settings to an individual slide, select the slide in the Slideshow Viewer, click the Effects tab in the Properties panel, and then specify the Pan and Zoom settings (such as East To West and Zoom In).

 When you select Random Pan & Zoom, you can see the pan and zoom direction of an individual slide by selecting the slide and viewing the pan and zoom settings in the Effects pane of the Properties panel. You can change the pan and zoom settings for the individual slide.

Scale slides

1. In the Slides area of the Slideshow Viewer, select the slides you want to scale.

- In the Properties panel, click the Basic tab.
- From the Scale menu, choose one of the following:

Scale And Apply Matte Proportionally scales the slide so that the entire image fits the frame, applying a matte as necessary to fill any blank area of the frame.

Scale And Crop Edges Proportionally scales the slide until it fills the frame, cropping any area that exceeds the frame.

Do Nothing Maintains the original dimensions of the image. The slide is centered. Any portion of the slide that exceeds the frame is cropped. Unfilled areas of the frame are matted in black.

If you want to emphasize a different part of the scaled image or change other crop or matte effects, edit the image in Photoshop.

Change the slide duration

- To specify the duration of all slides in the slide show, change the Slide Duration value in the Slideshow Options area of the Slideshow Viewer.
- To change the duration of individual slides, select one or more slides in the Slideshow Viewer, deselect Match Slideshow in the Basic pane of the Properties panel, and change the Duration value.

Let viewers manually advance slides

If you select Manual Advance, slides don't advance unless viewers click Next or Previous.

- To select Manual Advance for the entire slide show, deselect all slides, and select Manual Advance in the Slideshow Viewer.
- To select Manual Advance for individual slides, select one or more slides in the Slideshow Viewer, and select Manual Advance in the Basic pane of the Properties dialog box.

Create subtitles for slides

Adding subtitles to your slide show is easy. Use the name or description of each slide as the subtitle. You can change other options, such as the color group, stroke, and position of the subtitle. The starting time and duration of the subtitle match those of the slide.

- In the Slides area of the Slideshow Viewer, select the slide to which you want to add a subtitle.
- In the Properties panel, click the Basic tab, and select Create Subtitle.
- Select Name or Description to determine the text for your subtitle. (Make sure that you type a name or description at the top of the panel.)
- Choose an option from the Highlight Group menu.
- Choose the stroke weight for the subtitle text.
- Specify the alignment of the subtitle within the slide. Specifying 0% places the subtitle at the top of the slide, and 100% places the subtitle at the bottom of the slide.



Subtitles in slides



 *To change the subtitle, modify the name or description that you based the slide show on.*

 Twitter™ and Facebook posts are not covered under the terms of Creative Commons.

[Legal Notices](#) | [Online Privacy Policy](#)

Audio and subtitles

Audio clips

[About multiple audio tracks](#)

[Add audio to a timeline](#)

[Remove audio or subtitle tracks](#)

[Set audio and subtitle preferences](#)

About multiple audio tracks

[To the top](#)

A DVD or Blu-ray project can include as many as eight audio tracks. Traditionally, audio track 1 is used for the soundtrack of the video. The remaining seven tracks are used for supplemental audio, such as dubbed versions of the soundtrack, director's comments, teacher's notes, or coach's tips.

While a DVD or Blu-ray Disc can include eight audio tracks, a DVD or Blu-ray Disc player can play only one audio track at a time. Because two audio tracks cannot play simultaneously, all audio tracks must be complete within themselves. For example, if you want the same background music and sound effects in each dubbed language track, mix them with the voice track before you import them into a project. You can use an audio-editing application such as Adobe Soundbooth to combine audio sound effects, music, and dialog into a single audio clip.

Note: *Flash doesn't support multiple audio tracks.*

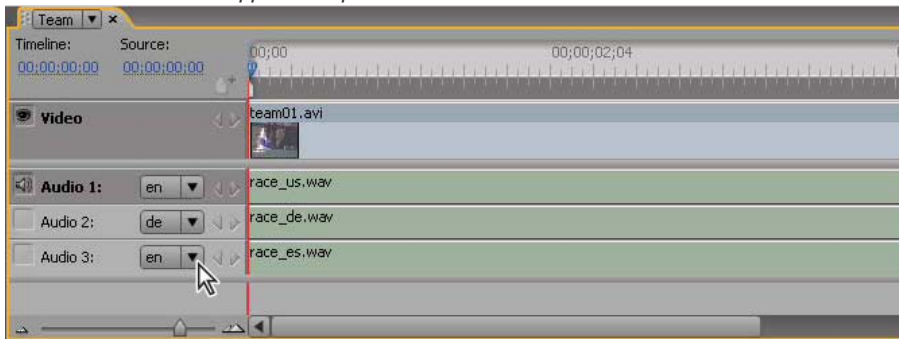

Timeline with multiple audio tracks

To have audio play while a menu displays, see [About motion menus](#).

Add audio to a timeline

[To the top](#)

You can place audio files on separate tracks, or you can place multiple audio files on the same track. Although an audio clip initially snaps to the beginning of the track, you can later reposition it or trim it if necessary. The Track Selector to the left of the track name lets you activate a track so that you can control which track you hear when playing the timeline.

Note: *When a single audio clip is used for multiple video clips, a hiccup in the audio occurs when the movie moves from one video clip to another.*

1. Import the audio clips as assets in the Project panel.
2. Use any of these methods to add audio clips to a timeline:
 - To create a new timeline that includes the audio clip, select an audio clip in the Project panel, and choose **Timeline > New Timeline**.
 - To add an audio clip to a new audio track in an existing timeline, drag the audio clip from the Project panel to the timeline, just below the video track or the last audio track. (To add a blank audio track, select the Timeline Viewer and choose **Timeline > Add Audio Track**.)
 - To add an audio clip to an existing track in the timeline, drag the clip from the Project panel into the track until the pointer changes to a "+", and then release the clip. Encore adds the clip to the right of the last clip in the track.
3. If you are adding audio in different languages, choose the appropriate language code from the Language menu on the left side of the track in the Timeline Viewer.
4. Add as many audio tracks as necessary (as many as eight per timeline). You can add multiple audio clips to a single track, or you can add them to separate tracks.

Note: *If you are adding multiple audio tracks to several timelines, make sure that you put similar audio on the same track*

number in each timeline. For example, put all director's commentary on Track #1 for every timeline. (See *Keeping track of tracks.*)

Remove audio or subtitle tracks

[To the top](#)

1. Open the timeline containing the track you want to delete.
2. Click one of the selection tools and, in the Timeline Viewer, select the track you want to delete.
3. Choose Timeline > Remove Audio Track or Remove Subtitle Track.

Set audio and subtitle preferences

[To the top](#)

You can determine the number of audio and subtitle tracks that appear by default when you create a timeline. You can also determine the default language and duration of subtitle clips.

1. Choose Edit > Preferences > Timelines (Windows) or Encore > Preferences > Timelines (Mac OS).
2. In the Timeline Defaults pane, do any of the following, and then click OK:
 - Specify the default number of audio tracks and the default audio language.
 - Specify the default number of subtitle tracks, the default subtitle language, and the default subtitle length. (Subtitles are not supported for Flash export.)

More Help topics

[Preview timelines](#)



[Legal Notices](#) | [Online Privacy Policy](#)

Subtitle basics

- [About subtitles in DVD projects](#)
- [Create subtitles manually](#)
- [Set subtitle properties](#)
- [Edit, reformat, or move subtitles](#)
- [Change the display time of subtitles](#)
- [Duplicate entire track of subtitles](#)
- [Export subtitle](#)

About subtitles in DVD projects

[To the top](#)

Subtitles generally translate the audio track, but also can be used to supplement the video, such as by providing captions, lyrics, hints, or different perspectives. Some designers create simple graphics by using subtitle image files to add pointers or to mask, highlight, or overlay areas.

You can type subtitles directly into a timeline or the Monitor panel, or import subtitles using scripts. Subtitle scripts can contain the subtitle text or can reference image files. Keep in mind the following information:

- Each screen of subtitles appears as a separate clip in the timeline, including subtitles you type in the Monitor panel.
- A timeline can include up to 32 subtitle tracks for standard, fullscreen video, and 16 subtitle tracks for widescreen video. However, a DVD or Blu-ray player can play only one subtitle track at a time.
- Subtitles are not incorporated into the video stream. Each track becomes a separate overlay, making it possible to display any one of the subtitle tracks over the same video.
- Subtitles are subpictures and have the same restrictions.
- Subtitles are limited to three colors, which map to the stroke, the fill, and partial anti-aliasing of the characters.
- You define the colors used in subtitles in a timeline color set.
- For Blu-ray projects that have video sizes larger than or equal to 1280x720, the gap between subtitle clips must be at least 5 frames.

Note: You may not be able to burn the Blu-ray project if the subtitle clips are placed without this gap.

Create subtitles manually

[To the top](#)

Using the Monitor panel, you can step through your video and type subtitles where needed. Just as when you type text on a menu, you can enter subtitle text either freely or constrained to a bounding box. If you first create a bounding box for the subtitles, the lines of text automatically wrap to the next line when they reach the edge of the box. You can resize the box to reflow the text. If you enter subtitles without a bounding box, the text is not constrained, and you must use the Enter key to break the text between lines.

1. Open the timeline to which you want to add a subtitle.
2. Do one of the following:
 - To add a new subtitle track, choose Timeline > Add Subtitle Track.
 - To add subtitles to an existing track, click the Track Selector (to the left of the subtitle track name) of the desired subtitle track.
3. Choose Window > Monitor to open the Monitor panel, and click the Show Safe Area button to display the safe area guides.
4. In the timeline, drag the current-time indicator to the first frame in which you want to add a subtitle.
5. Click either the Horizontal or Vertical Text tool.

The pointer changes to an I-beam within a dotted box. The small horizontal line near the bottom of the I-beam marks the position of the baseline, the line on which the type rests.

6. In the Monitor panel, do one of the following:

- Drag the I-beam pointer to define the bounding box for the subtitle.
 - Position the baseline of the I-beam pointer where you want the subtitle to begin, and click to set the entry point for the type. The insertion point appears.
 - Click the Add Subtitle button at the bottom of the Monitor panel, which opens an empty box with blue corner handles.
7. In the Character panel, select the type attributes and alignment options you want for this subtitle. You don't set the color for the subtitle text here, however. That is determined by the Highlight Group you specify in the Properties panel, which is based on a timeline color set.

8. In the Monitor panel, click in the text box and type the desired text.

 *To reposition the subtitle text, hold down the Ctrl key (Windows) or Command key (Mac OS) to temporarily activate the Move tool, and drag the text as needed. When you release the Ctrl or Command key, the text tool becomes active again.*

9. Click the Selection tool to exit text editing mode and select the subtitle clip in the timeline and the Monitor panel.

10. To change subtitle properties of the selected clip, set options in the Properties panel. (See [Set subtitle properties.](#))

11. Move the current-time indicator to the next frame to which you want to add a subtitle, and continue adding subtitles.

 *When you click the Add Subtitle button in the Monitor panel, the new subtitle matches the same character and paragraph attributes as the previous subtitle on the track.*

You can place only one text box per clip. You cannot place subtitles in separate areas of the frame unless the text is all within the same bounding box.

Set subtitle properties

[To the top](#)

1. In the timeline, select a subtitle clip.

Note: *To preview changes as you make them, make sure the current-time indicator is located over the selected subtitle clip in the timeline and the subtitle track is selected.*

2. Change any of the following options in the Properties panel:

- Choose the desired color group from the Highlight menu.
- Set the desired width option from the Stroke menu. The stroke outlines the type to increase the contrast and improve readability.
- Change the duration of the subtitle. (See [Change the display time of subtitles.](#))
- In the Alignment box, type a value from 0% to 100% and press Enter. For horizontal text, 0% aligns the text with the top of the bounding box, 100% aligns it with the bottom, and 50% aligns it with the horizontal center of the bounding box.

Edit, reformat, or move subtitles

[To the top](#)

You can edit subtitles that you typed in Encore or imported from a text subtitle script. You can modify either individual clips, a range of clips, or all the clips on a track.

Subtitle text is either constrained to a bounding box or typed in freely. (Subtitles that you import using a text subtitle script are placed in bounding boxes.) If text is constrained to a bounding box, you can change the line breaks by resizing the bounding box. If text is typed freely, you must manually change the line breaks.

Note: *Subtitles imported from an image-based script cannot be changed because they are imported as rendered images instead of text.*

1. Open the timeline containing the subtitle you want to change.
2. Make sure that the Track Selector on the track you want to edit is selected, and then select the subtitle clip.
3. Choose Window > Monitor to open the Monitor panel.
4. In the timeline, move the current-time indicator over the selected clip. You do not need to land on the first frame in which the clip appears; anywhere within the clip is fine.

 *To select all the subtitles on a track to make global changes (such as changing the font or color group), double-click the track name. Then make the desired changes in the Character or Properties panel. To select several subtitle clips, either Shift-click the desired clips in the track or drag a selection box around them.*

5. Do any of the following:

- To edit the subtitle, using the appropriate text tool, click an insertion point in the text or highlight the words you want to change. Then, type the new or replacement text.
- To restyle the text, using the appropriate text tool, highlight the words you want to change. Then, select the type attributes you want for the text in the Character panel.
- To reflow the subtitle, using the appropriate text tool, click an insertion point in the text. Then, place the cursor over a handle of the bounding box. When the cursor changes to a double-headed arrow, drag the handle to resize the bounding box. The text reflows as necessary to fit the new bounding box dimensions. (If you do not see a bounding box after you click an insertion point, you entered the text freely without a bounding box. You must manually change line endings in free-flow text.)

Note: Be sure to use a text tool when resizing the text block. If you drag a bounding box handle using a selection tool, it scales the text as if it were an object and the text does not reflow.

- To reposition the subtitle, click a selection tool, and place the cursor over the subtitle text. When the cursor changes to a black arrow, drag the subtitle to the desired location in the Monitor panel.
- To change the color group, stroke weight, or alignment, click a selection tool, and select the clip in the timeline. Then, change the appropriate option in the Properties panel. (These properties apply to the entire clip, not to individual characters.)

6. Move the current-time indicator to the next subtitle you want to edit, select the subtitle clip, and repeat the previous step.

 To move the current-time indicator and select a subtitle clip at the same time, click the Next Clip or Previous Clip button in the subtitle track, or use the Previous Subtitle or Next Subtitle button in the Monitor panel.

Automatically fix subtitle frame gaps for Blu-ray discs

Adjusts the gap separating consecutive subtitle clips in a timeline to five frames if the gap is less than five frames.

Encore displays an error if the gap between any two subtitle clips in a timeline is less than five frames. The Auto Fix Subtitle Frame Gaps feature automatically resizes one or both the flanking clips in a manner that the gap separating them is five frames.

However, the feature does not resize subtitle clips shorter than 12 frames in duration. In this case, fix the problem manually. Use the feature for all timelines on blu-ray discs, except for timelines with frame dimensions 720x480.

To use Auto Fix Subtitle Frame Gaps:

1. Right-click a problematic subtitle clip.
2. From the context menu, choose Fix Gaps

Note: Fixing gaps is not required for DVDs. You can successfully burn Encore projects on a DVD even if the gap between any two subtitle clips is less than five frames.

Change the display time of subtitles

[To the top](#)

Subtitles that you import into a timeline come with preset start and end times. When you create subtitles in Encore, the default duration is initially set to 2 seconds. You can change the display time by shortening or lengthening a subtitle clip in the Timeline Viewer, using the Trim Subtitle buttons in the Monitor panel, or by editing the Duration value in the Properties panel.



Note: To change the default duration for subtitles, choose *Edit > Preferences > Timelines (Windows)* or *Encore > Preferences > Timelines (Mac OS)*, enter a length of time for the Subtitle Duration, and click OK.

Change the display time of a subtitle using the Timeline Viewer

1. Open the timeline containing the subtitles you want to change.
2. To view your edits in the Monitor panel, make sure that the Track Selector (next to the track name) is selected on the subtitle track you want to change and the current-time indicator is over the subtitle clip.
3. Click a selection tool (either is fine), and position the pointer over the beginning or end of the subtitle that you want to adjust. The pointer changes to a red bracket with a double-sided arrow.
4. Drag the end of the subtitle to the desired frame to increase or decrease its length. As you drag, the Monitor panel displays the current frames so that you can judge where to position the clip's new start or end point.

Note: You can't increase the length of a subtitle unless there are empty frames adjacent to it.

Change the display time of a subtitle using the Monitor panel

1. Open the timeline containing the subtitles you want to change.
2. Make sure that the Track Selector (next to the track name) is selected on the subtitle track you want to change.
3. Select the clip you want to change.
4. Move the current-time indicator to the frame where you want the new In point or Out point to be.
5. In the Monitor panel, click either the Trim Subtitle In Point To Here button  or the Trim Subtitle Out Point To Here button .

Change the display time of a subtitle using the Properties panel

1. Open the timeline containing the subtitles you want to change.
2. Make sure that the Track Selector (next to the track name) is selected on the subtitle track you want to change.
3. Select the clip you want to change.
4. In the Properties panel, specify a different Duration, In-Point, or Out-Point value.

If you change the Duration value, the Out-Point value increases or decreases, depending on whether you increased or decreased the duration. If you change the In-Point value, the Out-Point value changes automatically. If you change the Out-Point value, the In-Point value changes automatically.

Change the default display time of subtitles

1. Choose Edit > Preferences > Timelines (Windows) or Encore > Preferences > Timelines (Mac OS).
2. For Subtitle Duration, type the number of seconds you want subtitles to display, and then click OK.

Encore changes the display time of all new subtitles. Existing subtitles remain unchanged.

Duplicate entire track of subtitles

[To the top](#)

After you create the first set of subtitles for a timeline, you can duplicate the entire track and use it like a template for other languages you need to create. Before you duplicate the track, make sure the subtitles are adjusted properly for each scene. This way, you need to change only the content of each subtitle. All other attributes, such as location in the scene, duration, font, formatting, color and position, will match the original set.

1. Click the track header of the subtitle track to duplicate.
2. Choose Edit > Duplicate.

Export subtitle

[To the top](#)

You can export subtitle tracks as text files. You can reimport the text files into your projects.

1. Do one of the following:
 - Select Timeline > Export Subtitles > Text Script.
 - Right-click on the subtitle track and choose Export Subtitles.

 Twitter™ and Facebook posts are not covered under the terms of Creative Commons.

[Legal Notices](#) | [Online Privacy Policy](#)

Subtitle scripts

[About script files](#)

[Import text script files](#)

[Import subtitle image files using scripts](#)

[Structure of script files](#)

About script files

[To the top](#)

You import subtitles using a script file. Encore accepts three different types of script files: Text Scripts, Image Scripts, and FAB Image Scripts. Scripts specify the start and end timecode of the subtitles. The big difference between them is that text scripts contain the subtitle text, whereas the two types of image scripts reference predesigned and formatted image files.

Unlike image-based subtitles, text script files include the subtitle text along with the timecode for the start and end point for each subtitle. Text scripts contain no screen position or formatting information. You format and position the subtitles as a group when you import them using the Import Subtitles (Text Script) dialog box. You can specify the track on which you want to position subtitles, language, color set, and group that are used when displaying them.

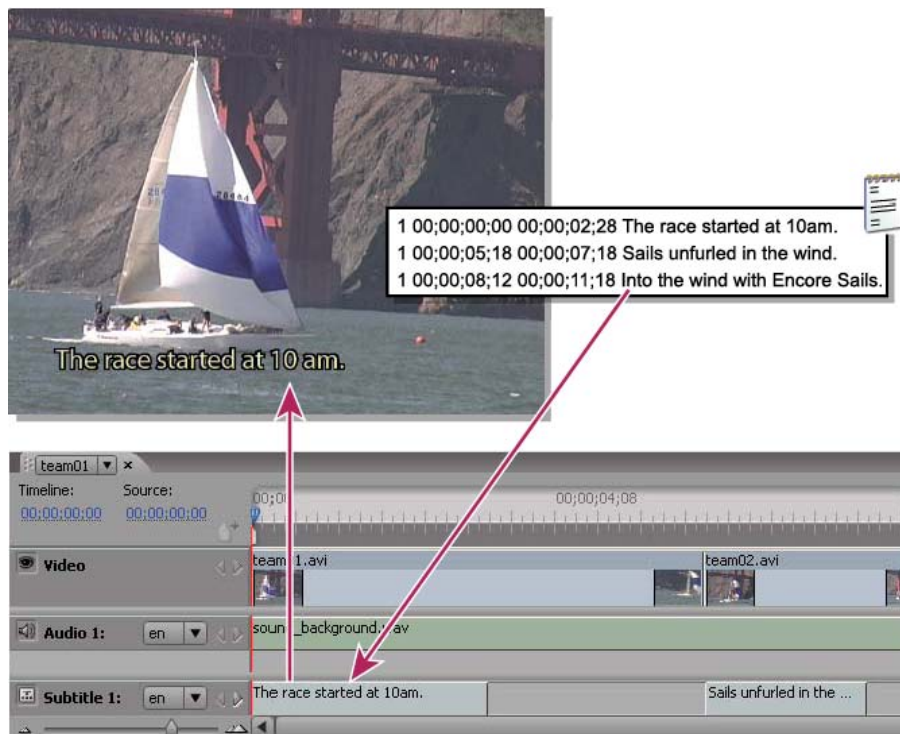

Importing subtitles

Import text script files

[To the top](#)

1. Open the timeline to which you want to add subtitles.
2. Choose Timeline > Import Subtitles > Text Script.
 -  You can import directly from the timeline by right-clicking (Windows) or Control-clicking (Mac OS) the subtitle track header and choosing the appropriate import option from the menu.
3. Locate and select the script you want to import, and click Open.
4. In the Import Subtitles (Text Script) dialog box, format the text, position the subtitles within the frame, and specify the track, language, and timecode offset as needed.

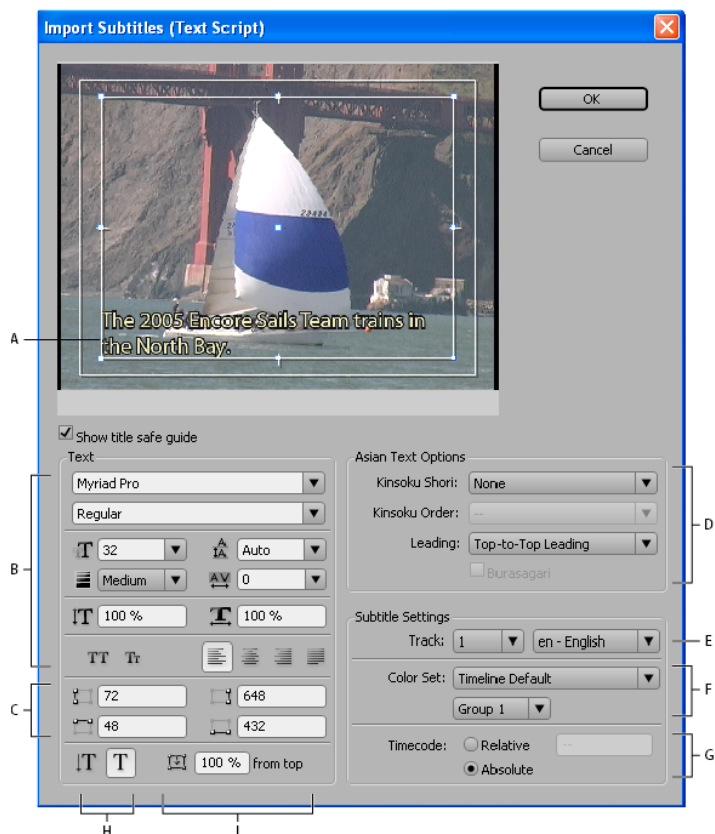

Import Subtitles (Text Script) dialog box

A. Subtitle within bounding box **B.** Text formatting and alignment options **C.** Coordinates of the text bounding box **D.** Options for formatting Chinese, Japanese, and Korean (CJK) characters **E.** Subtitle track and language **F.** Color set options **G.** Timecode offset options **H.** Text orientation **I.** Text position within bounding box

Text Script import options

The Import Subtitles (Text Script) dialog box includes the following options:

Text formatting options Set the font, font style, stroke, and other attributes of the text. These options are the same as those in the Character panel except for Faux Bold, Faux Italic, and Set Stroke Weight. A stroke (or outline) can increase the contrast between the subtitles and the video and improves readability.

Bounding box coordinates Adjust the position and size of the bounding box. Each value specifies the screen pixel coordinate for an edge (left, right, top, and bottom). If necessary, you can also adjust the size of the bounding box for each clip after you place it. (See [Edit, reformat, or move subtitles.](#))

Text orientation Sets the orientation of the text, either horizontal **T** or vertical **↓T**.

Text position within bounding box Sets the position of the clip within the bounding box. A value of 0% aligns the first line of the subtitle with the top of the bounding box for horizontal text, and with the right edge of the bounding box for vertical text. A value of 100% aligns the last line of the subtitle with the bottom edge of the bounding box for horizontal text, and with the left edge of the bounding box for vertical text.



Comparison of position values for horizontal text

A. 0% **B.** 50% **C.** 100%

Asian text options Specify options for formatting Chinese, Japanese, and Korean (CJK) characters (also known as double-byte characters). (See [Adding text to menus.](#))

Subtitle track and language Lists the available subtitle tracks or lets you specify that a new track be created for the subtitles. Also lets you designate the language of the subtitles.

Color set options Applies a color set to the timeline and a color group to all the subtitle clips in the script. You can later change the color group for individual clips using the Properties panel.

Timecode offset options Determines whether the script timecode is interpreted exactly (Absolute) or offset by a specified amount (Relative). For

example, when a clip has a source timecode that starts at 01:00:19:09 and a subtitle script has been logged for it using that timecode, you would set the Relative value to 01:00:19:09 on import to ensure that the imported subtitles synchronize correctly with the clip's audio.

[To the top](#)

Import subtitle image files using scripts

You can import subtitle image files using two different types of scripts: image scripts and FAB image scripts. Both types reference image files that contain subtitles, simple graphics (such as pointers or masks), or both. Because the image files are preformatted and prepositioned, you cannot edit them in Encore.

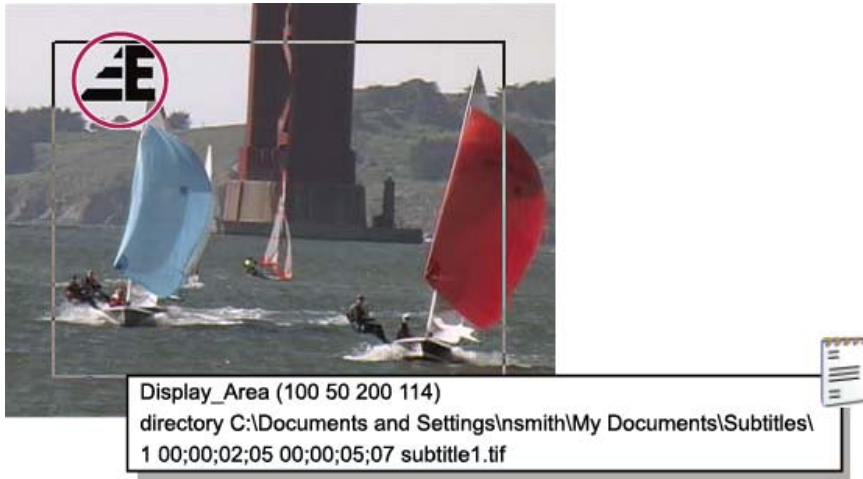

Subtitle image and sample script

Although many professionals obtain image files from a subtitling house or service, you can create your own. As with the subpictures you create to highlight buttons, you achieve the best results by limiting image files to three colors or fewer. Use sharp edges for text and graphics, avoiding gradients, feathering, or anti-aliasing. Image files can be in JPG, GIF, PNG, TIF, or BMP format. When you import an image-based script, you specify how to map the colors in the image to the colors in the Timeline Color Set.

Note: *Image scripts (except FAB files) contain an absolute path to the image files. Before you import a script, make sure that the image files are in the location it specifies.*

1. Open the timeline to which you want to add subtitles.
2. Choose Timeline > Import Subtitles > FAB Images Script or choose Timeline > Import Subtitles > Image Script.

 *You can import directly from the timeline by right-clicking (Windows) or Control-clicking (Mac OS) the subtitle track header and choosing the appropriate import option from the menu.*

3. Locate and select the file you want to import, and click Open.
4. For FAB script files only, locate and select the folder containing the image files; then click OK.
5. In the Map Colors dialog box, select an eyedropper, position it over the appropriate area in the image, and click to select the color. Repeat for all three eyedroppers.

Note: *Ensure that you set a different color for each of the options. If you choose the same color, the final output, sometimes, is not as expected..*

Each eyedropper controls the color mapping of the image to the subtitle color set as follows:

Background Maps to the transparent area of the subtitle overlay. Place the eyedropper over the background of the subtitle image.

Fill/Color 1 Maps to the fill of the type. Place the eyedropper over the body of the type (or, for nontext subtitles, over the object you want mapped to Color 1).

Outline/Color 2 Maps to the outline of the type. Place the eyedropper over the outline of a character (or, for nontext subtitle files, over the object you want mapped to Color 2).

Note: *Any additional colors in the image become transparent.*

6. Click OK.
7. In the Subtitle Settings area of the Import Subtitles dialog box, specify the appropriate settings for the following options, and click OK:
 - From the Track menu, specify the subtitle track to which these subtitles should be placed and identify the language of the subtitle.
 - From the Color Set menus, choose a color set and highlight group to use for the subtitles. The color set you select is used for all the subtitles on all tracks in the timeline. The color group applies to all subtitles in this script.

- Select Relative to offset the timecode of each subtitle. You specify the offset in the adjacent box. Select this option if the script's timecode matches the source timecode of a clip in the timeline.
- Select Absolute to import the subtitles at the timecode of the timeline itself (for instance, starting at zero).

[To the top](#)

Structure of script files

Script files are text-only files that are easy to write and edit in a text-editing application. For large projects, subtitling is generally handled by a subtitling house or service, which may create either text- or image-based scripts. If you want to create your own scripts or modify an existing script, it is important to understand the structure of script files.

Important: *Regardless of the type of script (text or image based), always save a script as a text file (TXT). To ensure that all the characters are correctly interpreted, choose Unicode UTF-8 or UTF-16 encoding when you save. This encoding option is available for text files in most text editors, such as Microsoft Notepad or TextEdit for Mac OS.*

Structure of text script files

Text script files specify the subtitle number, the start time and end time in the video, and the subtitle text. You separate each line of a clip with a return. You format the text, position the subtitles on the screen, and choose the color group when you import the file.

Text subtitle scripts should follow this format:

Subtitle_# Start_Timecode End_Timecode Subtitle_text

Additional_line_of_subtitle_text

Additional_line_of_subtitle_text

You can use either spaces or tabs to separate the elements in the script, and the Enter key to separate lines within the script. If you want to break the subtitle text into separate lines, just use the Enter key to start a new line.

Keep in mind, however, that after you import the subtitles, the point size of the text and the size of the bounding box may force the text to reflow, causing unexpected line breaks.

In this example, the following lines would form two separate clips, one at 2:02 and the second at 5:18:

1 00:00;02;02 00:00;03;15 The cat never came back.

She just walked away.

2 00:00;05;18 00:00;09;20 I hope she's all right.

She always looked out the window with a special kind of longing.

Structure of image scripts

In image scripts, the first line designates the screen position, in pixel coordinates, of all image files. The second line includes a path to the folder containing the image files. The path is absolute, not relative, so make sure that you update the path if you move the image files. All remaining lines reference a single subtitle per line, specifying the subtitle number, the start and end time, and the filename of the image file containing the subtitle.

The format of an image script file is as follows (italicized text represents the text you replace):

Display_Area (Left Top Right Bottom)

Directory Path

Subtitle#Start_timecode End_timecode Image_file_name

The display area uses the frame pixels for coordinates (for example, 720 x 480 pixels for NTSC or 720 x 576 pixels for PAL), where the zero point is the upper-left corner. You can separate the elements on each line using spaces or tabs.

In this example, the full-screen images overlay the entire screen:

Display_Area (000 000 720 480)

Directory C:\Subtitles\Image Files\Caption Inc Images\ (Windows) or

directory /Subtitles/Image Files/Caption Inc Images/ (Mac OS)

1 00:00;02;02 00:00;03;15 CATTALESS001.TIF

2 00:00;05;18 00:00;09;20 CATTALESS002.TIF

Structure of FAB image scripts

FAB image scripts contain separate position information for each image file. Unlike image scripts, you specify where to find the image files when you import a FAB image script. Each line of the file references a single subtitle image file, its start and end time in the video, and the pixel coordinates for its upper-left corner and lower-right corner. FAB subtitle scripts use the following format:

Image_file_name Start_Timecode End_Timecode Left Top Right Bottom

The position values use the frame pixels for coordinates (for example, 720 x 480 pixels for NTSC or 720 x 576 pixels for PAL), where the zero point is the upper-left corner. You can separate the elements on the lines by using spaces or tabs, and separate the lines within the script by using the Enter key.

In this example, the full-screen images overlay the entire screen:

```
RACE001.TIF 00;00;02;02 00;00;03;15 000 000 720 480
```

```
RACE002.TIF 00;00;05;18 00;00;09;20 000 000 720 480
```

Timecode format

It is important that your script files correctly specify the timecode for your project. The timecode you use depends on the television standard of the project:

NTSC NTSC projects use drop-frame timecode, which separates the numbers with semicolons, as in hh:mm:ss;ff (hours; minutes; seconds; frames).

PAL PAL projects use timecode that separates the numbers with colons, as in hh:mm:ss:ff (hours: minutes: seconds: frames).

When specifying timecode, keep in mind the following concepts:

- Timecode in a script should match the timecode format of the project so that the subtitles sync correctly with the audio and video. While Encore can convert non-drop-frame timecode to drop frame, you get the best results if you specify the appropriate timecode for a project.
- Timecode numbers do not need leading zeros. For example, 0;0;12;3 would be correctly interpreted as 00;00;12;03 on import.
- Some subtitle-editing applications save subtitle scripts using the Time format instead of timecode. Time format is in the form: hh:mm:ss,zzz (hours; minutes; seconds, milliseconds). Encore does not recognize Time format. To convert Time format to timecode, you need to convert milliseconds (zzz) to frames (ff). The formula is:

NTSC: Frame # = (milliseconds x 29.97) ÷ 1000

PAL: Frame # = (milliseconds x 25) ÷ 1000



[Legal Notices](#) | [Online Privacy Policy](#)

Subtitle colors

About subtitle colors

Define a color set for subtitles

Import and export timeline color sets

Apply color to subtitles

About subtitle colors

[To the top](#)

Timeline color sets specify the colors used in subtitles. You can use the same color set for the entire project or define a color set for each timeline. A color set is divided into three groups. You can select the appropriate color group for each clip to ensure maximum visibility or to distinguish, for example, between characters in a film. Before you define the colors, it is important to understand the following concepts:

- A timeline color set consists of a maximum of nine colors, each with its own opacity setting.
- The colors are divided into three subtitle groups so that you can vary the subtitle colors depending upon the background or speaker.
- Each subtitle group contains a value for the fill, stroke, and anti-alias color.



Subtitle

A. Fill color **B.** Stroke color **C.** Anti-alias color

- Each timeline can reference only one color set.
- Each subtitle clip can reference one of the three groups within the color set assigned to the timeline.
- You can modify the default set or create your own color sets.
- You can save color sets and use them in other projects.
- If you edit a color set, Encore automatically updates all timelines that use that color set.

Note: Subtitles are not supported for Flash projects.

Define a color set for subtitles

[To the top](#)

1. Open the timeline containing the subtitle colors you want to change.

 *To preview the colors as you edit them, move the current-time indicator to a subtitle clip. Make sure that the Monitor panel is visible. Then, after step 4, click the Preview button in the Timeline Color Set dialog box.*

2. Choose Timeline > Edit Timeline Color Set.
3. In the Timeline Color Set dialog box, select Preview if you want to see the results of the color changes as you make them.
4. In the Timeline Color Set dialog box, click the New Color Set button .
5. In the New Color Set dialog box, type the name of the new color set, and click OK.
6. Click the color swatch of any color that you want to change.
7. Adjust the color using one of the following methods (the color you select appears in the top half of the color swatch; the original color remains in the bottom half):
 - Locate the color range you want by using the triangle sliders on the color spectrum bar, and then click the desired color in the color field.
 - Change the numeric values for Hue, Saturation, Brightness, Red, Green, or Blue.
8. Click OK. The new color replaces the original color in the Timeline Color Set dialog box.
9. Choose the desired opacity level from the Opacity menu adjacent to the color swatch.

10. Repeat steps 5 through 9 for any color you want to change.
11. For any subtitle group, select Create Anti-Alias Color From Fill And Stroke to automatically create an anti-alias color based on the values for Fill and Stroke. Selecting this option disables the manual anti-alias color setting.
12. Click OK when you have defined all the colors to your satisfaction. The new color set is assigned to the timeline.
You can delete a color set you create, or you can export a color set for use in other projects.

[To the top](#)

Import and export timeline color sets

You can share timeline color sets between projects. You can export a customized color set from one project, and import the color set into another project.

Export a timeline color set

1. Open a timeline that uses the color set you want to export.
2. Choose Timeline > Edit Timeline Color Set.
3. Select the color set from the Color Set menu.
4. Click the Export To Color Set File button .
5. Type a new name for the color set, browse for the appropriate folder in which to save it, and click Save. Encore saves the color set, adding the extension .cs to the filename.
6. Do one of the following:
 - To apply the currently selected color set to the timeline, click OK.
 - To leave the timeline settings unchanged, click Cancel. (This does not cancel the export.)

Import a timeline color set

1. Open the timeline to which you want to apply the imported color set.
2. Choose Timeline > Edit Timeline Color Set.
3. Click the Import From Color Set File button , locate and select the file, and then click Open.
4. Click OK.

Encore applies the color set to the active timeline.

[To the top](#)

Apply color to subtitles

All subtitles in a timeline use colors from the same timeline color set. You can vary the colors of the subtitle clips by applying a different color group from within that color set.

Change the color set applied to subtitles

1. In the Project panel or the Timelines panel, select the timeline containing the subtitle colors you want to change.
2. In the Properties panel, choose the desired set from the Color Set menu.

Change the color group applied to a subtitle clip

You can use color groups to vary the subtitles depending upon the background or to help identify or distinguish between subtitles (such as to identify speakers).

1. Open the timeline containing the subtitle colors you want to change.
2. Select the subtitle clip (or clips) that you want to alter in the timeline. To select all the subtitles on a track, double-click the track name. To select several subtitle clips, either Shift-click the desired clips in the track or drag a selection box around them.
3. In the Properties panel, choose the desired color group from the Highlight menu.

To see the changes, move the current time indicator over the subtitles in the Timeline Viewer or click the Previous Subtitle and Next Subtitle buttons in the Monitor panel.

Navigation for audio and subtitle tracks

Keeping track of tracks

Set the default audio and subtitle tracks

Set buttons to select audio or subtitle tracks

Indicate the active audio or subtitle track

Keeping track of tracks

[To the top](#)

DVD players remember audio and subtitle track selections. Once a viewer specifies an audio track (using a menu or the remote control), the player plays that same track for all timelines in the program. If a timeline does not contain the specified track, the player defaults to the Audio 1 or Subtitle 1 track for the rest of the project, even if subsequent timelines contain the originally specified track.

The player references tracks by number, not by the language settings. If you have more than one timeline, each with several audio or subtitle tracks (such as language voiceovers or subtitles), use the same track for related audio or subtitles throughout the project. For example, place all Spanish subtitles on the same numbered subtitle track in each timeline, and place all director's comments on the same numbered audio track.

Set the default audio and subtitle tracks

[To the top](#)

When a DVD project includes audio tracks, subtitle tracks, or both, it is important to set the default tracks for the disc and to give the viewer a way to select the tracks. You do this by setting the Disc properties for default tracks. The DVD player will play these tracks throughout the program unless the viewer changes the selection.

1. To make the Disc properties appear in the Properties panel, do one of the following:
 - Click in a blank area in the Project panel (such as the lower-left edge of the panel).
 - Activate the Build panel by clicking its tab. When the Build panel is active, the Properties panel contains the Disc properties.
Note: If the Build panel is not open, you can open it by choosing Window > Build.
2. In the Properties panel, do one or both of the following:
 - If your project includes audio tracks, choose the track you want as the default from the Set Audio pop-up menu.
 - If your project includes subtitle tracks, choose the track you want as the default from the Set Subtitle pop-up menu.

The default setting for Set Audio and Set Subtitle is No Change, which leaves the audio track as set in the DVD player. For example, if a viewer has a DVD player set to French, and a DVD has a track identified as French, the DVD player chooses the French track automatically if No Change is selected.

Set buttons to select audio or subtitle tracks

[To the top](#)

While most remote controls have a button to select the audio and subtitle tracks, it is best to create a menu that includes options specific to your project. If you are using these tracks for material that is not language specific (such as to provide captions, lyrics, hints, or different perspectives), a menu can provide the viewer with buttons for the appropriate choices. A menu can also show the viewer the currently active audio or subtitle track.



Linking menu items to audio and subtitle tracks

Audio and subtitle selection is a button property that you set along with the button's destination link. After the viewer activates the button, the track setting remains in effect for all subsequently viewed timelines, unless reset by the viewer or specifically reset by a link control (such as End Action or Override).

You can set the audio or subtitle track with any link control in the Properties panel. For example, if you want the subtitle track selection to apply only to the destination timeline, you can set it either to off (subtitle tracks only) or back to a specific track using the button's Override property. When the timeline ends, the override setting resets the track.

1. In the Menus panel, select the desired menu or double-click the menu to open it in the Menu Viewer.
2. Select a button to set the audio track, subtitle track, or both.
3. In the Properties panel, choose Specify Link from the Link pop-up menu.
4. Select the desired menu or timeline for the destination of the link.
5. Do any of the following to set the track for the destination you specified:
 - If you want this button to change the audio track setting, select a track number from the Audio pop-up menu.
 - If you want this button to change the subtitle track setting, select a track number from the Subtitle pop-up menu.
6. Click OK.

 To preview the links to the subtitle and audio tracks, choose *File > Preview*, and then test the links. (See [Preview a project.](#))

Indicate the active audio or subtitle track

[To the top](#)

You can indicate to the viewer which audio or subtitle track is currently active when a menu is displayed. For example, if a viewer uses a menu to turn on French subtitles, watches the DVD, and then returns to the menu with subtitle options, the French subtitle option is selected, even if it wasn't the default.

1. In the Project panel, select a menu that acts as a setup menu for the audio or subtitle tracks.
2. In the Properties panel, choose Active Audio Track or Active Subtitle Track from the Default Button menu.

More Help topics

[About subtitles in DVD projects](#)



[Legal Notices](#) | [Online Privacy Policy](#)

Closed captions

[About closed captions](#)
[Add closed captions to video](#)

About closed captions

[To the top](#)

Closed captions provide assistance for the hearing impaired. Through captioning, the audio portion of a program appears as text superimposed over the image. Closed captions include dialogue, as well as descriptions of sounds in the program. Only the NTSC television standard accepts closed captions; PAL does not.

You create closed captions using a third-party captioning application, exporting them as source safe format (SCC) files. You then reference the SCC files by assigning them to clips in a timeline, using the Video Clip Properties panel. Closed captions will synchronize with the source timecode of the video clips you assign them to.

Note: *Closed captions are not supported for Blu-ray or Flash projects.*

Add closed captions to video

[To the top](#)

Closed captions that you add to your DVD project will only appear on the final DVD; they do not appear in Encore, in either the Monitor panel or Project Preview window.

1. In the Timeline Viewer, select the video clip to add closed captions to. If necessary, Alt-click (Windows) or Option-click (Mac OS) to select the video track separately from its audio track.
2. In the Video Clip Properties panel, click the Browse button for Field 1. Locate and select the SCC file that contains the closed captions, and then click Open.

Note: *Moving the SCC file or the Encore project file will break the links to the closed captions. To reset the links, repeat these steps to select the video clip, click Browse in the Video Clip Properties panel, and reselect the SCC file.*



[Legal Notices](#) | [Online Privacy Policy](#)

Creating and managing links

Playlists and chapter playlists

Playlists

Create a playlist

From an expert: Building playlists

Edit a playlist

Chapter playlists

Create a chapter playlist

Edit a chapter playlist

Designing end actions

Playlists

[To the top](#)

A *playlist* is a group of timelines, slide shows, or chapter playlists that play sequentially (from each one's specified chapter) and can include one end action. Playlists provide more efficient navigation possibilities than end action overrides alone. After creating a playlist, you populate and edit it by using the Playlist Properties panel. You can specify different audio and subtitle tracks for timelines accessed from a playlist also. You can choose playlists as a link or an end action from other elements. A playlist plays back all the elements included and cannot be interrupted, except by the viewer using the remote control. You can also chain multiple playlists together using end actions.

Note: *Playlists govern multiple timelines. To order chapters within a single timeline, use chapter playlists.*

Playlists let you set the order of playback for several elements at once, making authoring more efficient. For example, if a project includes a collection of short films, with director interviews and critical reviews for each, all contained in separate timelines, you can organize them in a variety of ways using playlists. You could create a menu with a Play All button to play each short film, the interview, and critical reviews in a linear fashion. The Play All button links to a playlist that contains all the timelines laid out in a linear order (first short film, interview, review, second short, interview, review, and so on). To play only the shorts, you'd create a Play Shorts button that links to a playlist that contains only the short films' timelines. If the project includes several films by the same director, you could make a button for that director, which links to a playlist that contains the director's short films, interviews, and reviews—and present them in any order you wish.

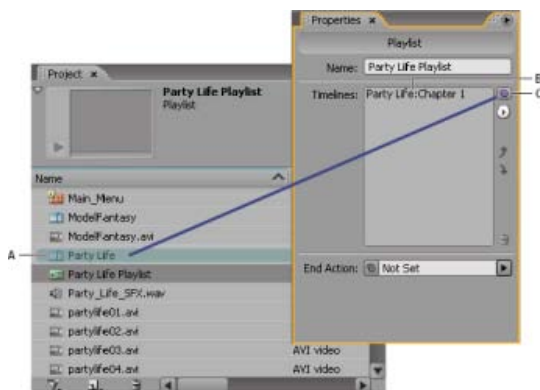

Drag pick whip (C) to timeline (A) to add it to playlist (B) displayed in Playlist Properties panel.

Encore provides the following options for chapter playlists in timelines for Blu-ray and Flash projects:

- Sequential: Play chapter playlists sequentially
- Random: Let the Blu-ray player play a set of chapters randomly. It may play the same chapter multiple times or play multiple chapters.
- Shuffle: Play all the chapters in random order.

Encore provides only the Sequential option for chapter playlists of DVD projects. You can access these options in the Chapter Playlist panel.

Create a playlist

[To the top](#)

1. Select the timelines and slide shows you want in the playlist. To select noncontiguous items, hold down the Ctrl key (Windows) or the Command key (Mac OS) key while you click them.
2. In the Project panel, choose Playlist from the Create A New Item menu  at the bottom of the panel, or choose File > New >

Playlist.

3. Enter a name for the playlist, and click OK. Encore creates a playlist and populates it with the selected assets.
4. Select the playlist in the Project panel, and bring the Playlist Properties panel to the front, if it's not visible.
5. Edit the list of assets in the Playlist Properties panel as desired, by rearranging the order, or deleting or adding more of the assets. (See [Edit a playlist](#) next.)
6. If desired, set an end action using the End Action pop-up menu or the pick whip. If you don't set an end action for the playlist, then the end action of the last asset in the playlist will be activated.

Edit a playlist

[To the top](#)

Use the controls on the right side of the Playlist Properties panel to edit the items in the playlist, including the pick whip, a pop-up menu, and the Up and Down Arrow buttons.

1. Select a playlist in the Project panel.
2. Edit the playlist as follows, using the Playlist Properties panel:
 - To reorder the timelines and other assets, select them one at a time and use the Up and Down Arrow buttons to move them each to a new location in the list.
 - To add a timeline, slide show, playlist, or chapter playlist to a playlist, drag the pick whip to the asset in the Project panel or Timelines panel or to a chapter point or a slide in the Timeline or Slideshow viewers. Encore adds the asset to the end of the playlist.
 - To delete an asset, select it and click the Delete icon or choose Delete from the pop-up menu. You can select multiple, noncontiguous elements by holding down Ctrl (Windows) or Command (Mac OS) and clicking each one.
 - To specify a different audio or subtitle track for the asset, choose Specify Link from the pop-up menu. In the Specify Link dialog box, select the asset, specify the new tracks using the Audio and Subtitle menus, and click OK.

Chapter playlists

[To the top](#)

Chapter playlists function much as playlists do, but provide a means of playing a single timeline's chapters in a nonsequential order. You can also use chapter playlists to change the end action or other timeline properties. After creating a chapter playlist, you populate and edit it by using the Chapter Playlist Viewer.

Note: *You use chapter playlists to link together chapters within a single timeline; you use playlists to link together multiple timelines.*

For example, suppose the main timeline for a pottery-making video progresses from an introductory workflow to a discussion of tools (with chapter markers for each tool type) to a series of demonstrations (chapters for making a bowl, a vase, a pitcher, and a plate), then to glazing and, finally, to firing in the kiln. With chapter playlists, you can quickly create different paths for different viewers.

You make a main menu with buttons to play the entire video, or to play each demo separately. To play the entire video, you simply link that button to the main timeline. To play the individual demonstrations, you create a chapter playlist for each possible path you want (a bowl chapter playlist, a pitcher chapter playlist, and so on). When the viewer clicks the pitcher demo button, for example, which is linked to the pitcher chapter playlist, the pitcher demo plays, then glazing, and so forth—the viewer sees only the relevant parts. Or you could create a chapter playlist for the viewer who only wants to see the overall workflow, without watching the individual demonstrations. In this instance, you create a workflow chapter playlist, and add to it all the chapters except the demonstration chapters.

Create a chapter playlist

[To the top](#)

You can create a chapter playlist to present the chapters of a timeline in a nonsequential order.

1. Choose File > New > Chapter Playlist, or choose Timeline > New Chapter Playlist. If a timeline is selected, a chapter playlist is created from it. If no timeline is selected, Encore prompts you to choose one.
2. In the Chapter Playlist Viewer, either select the chapters you want to work with on the left side of the viewer, and then click the Add button , double-click them, or drag them to the Chapter Playlist on the right side of the viewer.
3. Arrange the chapters in their new order by dragging them in the Chapter Playlist.
4. Specify the necessary links and other settings by selecting a chapter on the left side of the viewer (in the Master Timeline list) and making updates in the Properties panel.

Edit a chapter playlist

1. Double-click the chapter playlist in the Project panel to open it in the Chapter Playlist Viewer.
2. Edit the playlist as follows in the Chapter Playlist Viewer:
 - To add a chapter, drag it from the left side of the viewer to the list on the right side or double-click it.
 - To reorder the chapters, drag them to new locations in the list on the right side of the viewer.
 - To delete a chapter, select it in the Chapter Playlist on the right and click the Delete icon. You can select multiple, noncontiguous chapters by holding down the Ctrl key (Windows) or Command key (Mac OS) and clicking each chapter.

 Twitter™ and Facebook posts are not covered under the terms of Creative Commons.

[Legal Notices](#) | [Online Privacy Policy](#)

Navigation through links

[Project navigation and links](#)
[Link destinations](#)
[Setting navigation and properties](#)

[To the top](#)

Project navigation and links

Menus and their buttons provide the primary method for a viewer to move through the content. In addition, authors can set end actions, overrides, and other navigation details to help guide the viewer. For example, a viewer activates a button to play a video. What happens when that video finishes playing is determined by the end action set by you, the author. Your goal is to make project navigation intuitive and streamlined for the viewer.

Adobe® Encore® lets you link to practically any destination in the project, whether it be a menu, timeline, slide show, playlist, or chapter playlist. (ROM content is the exception. ROM content must be accessed by using a computer.)

 For interactive Flash projects, you can set standard button links or end actions to link to a menu containing an embedded web link. Thus, when a viewer clicks a button or when an item finishes playing, a web page outside your project is automatically displayed. (See [Embed web links in your Flash project.](#))

You can set the following types of links to create navigation:

First Play Specifies what plays when you insert the DVD or Blu-ray Disc into a player, or when you open the Flash SWF file in a web browser. For Hollywood video discs, the first play link typically starts an FBI warning. The first play could also display the main menu of the disc, if the copyright warning isn't required. To specify the first play, see [Set disc properties and navigation](#).

Title Button Specifies what happens when the Title button on the remote control is pressed. Typically, the Title button links to the main menu. To specify the Title button link, see [Set disc properties and navigation](#). To disable the Title button on the remote control, see [Disable or edit user operations](#).

Menu Remote Specifies what happens when the viewer presses the Menu button on the remote control while content is playing. You set Menu button links for timelines and slide shows. Typically, the Menu button links back to the menu for the current feature. To specify the Menu button link, see [Set timeline navigation](#). To disable the Menu button on the remote control, see [Disable or edit user operations](#).

Standard link Specifies what happens when a viewer activates a button on a menu. To specify standard links, see [Specify a link](#).

End Action Specifies the action when an item finishes playing, or when you have specified an active duration for a menu. End actions specify the destination to display next such as a menu, timeline, or any other element. To let viewers watch video clips individually or in succession, set the end action of each clip to take the viewer to the next clip. Or, you could have the end action lead back to the menu from which the viewer accessed the clip.

End actions for menus are optional. You use them when you want to control the display if a viewer does not activate a button on the menu. Menu end actions are useful in projects that remain playing in a public place or educational setting. If a viewer leaves, for example, the menu can jump back to the main menu after a wait period, to be ready for the next person.

End Action Override Use this optional setting to override the end action of the destination. The standard link sets the next destination; the override sets the end action of that destination, replacing its default end action. Overrides give you dynamic control over the navigation through a project. You can change the path according to what the viewer has watched.

For example, to create a music DVD, you could place the video for each song on its own timeline. The end action of each timeline would point to the next timeline so that the viewer could play the entire disc if desired. When creating the menu, you simply link the Play All button to the first timeline, and each playback automatically leads to the next.

If the viewer wants to play the clips individually, you can make the player to return to the main menu after playing a single timeline. For achieving this, you create separate buttons for each timeline. Then you link each button to its individual timeline and set the override for the link (by using the Properties panel of the button) to display the menu. When the viewer presses the Song 1 button, the first timeline plays. When it ends, the end action override of the Song 1 button returns the viewer to the menu. For a video tutorial on creating disk navigation, see www.adobe.com/go/lrvid4231_enc.

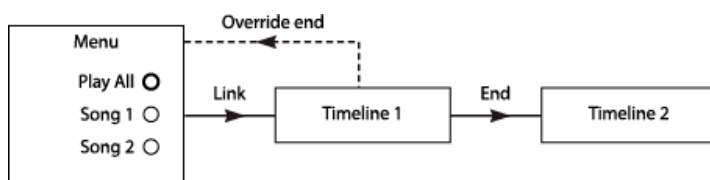

Sample use of override: Song 1 links to Timeline 1. End action of Timeline 1 leads to Timeline 2. Override option for Song 1 changes end action of Timeline 1 so that it returns to menu.

 Playlists let you create this type of navigation scheme even faster than using overrides. For more information, see [Playlists](#).

Link destinations

All links in Encore point to a menu, a timeline, a playlist, a chapter playlist, or a slide show. (Buttons can also contain a link transition attribute.) When you set a destination link, you can also control button highlighting or specify a chapter within an element.

Menu and button When linking to a menu, you can designate the button to be highlighted (selected) when the menu appears. Encore uses button 1 as the default button. You can choose any button in the menu to be highlighted, or you can choose Default. If you choose Default, Encore uses the default until the viewer chooses a button. After the viewer chooses a button, that button is highlighted whenever the menu is accessed.

Controlling which button is highlighted improves the usability of your project. It lets you control the menu depending on where the viewer has just been. You generally highlight the button that the viewer just activated, which helps the viewer keep track of what clip has just played. For example, a video's end action can point back to the menu and its own button. After the viewer watches the video, the end action leads to the menu, highlighting the video's button, not the default button. (Of course, you could also choose to highlight the button for the next video, to anticipate the viewer's progress through the project.)

Timeline and chapter When linking to a timeline, you also specify one of its chapter points. The chapter point indicates the starting location within the timeline. Hollywood DVDs typically include a scene index menu that uses a single timeline for the entire movie with chapter points for each scene.

Playlist A playlist is a group of timelines, slide shows, and chapter playlists that play sequentially. When linking to a playlist, you can also choose an end action.

Chapter playlist A chapter playlist is a collection of chapters within a single timeline. When linking to a chapter playlist, you can also specify an end action.

Note: *Blu-ray disc players do not support chapter playlists.*

Slideshow When linking to a slide show, you also choose one of its chapters (individual slides).

Link transition When specifying a button link, you can also specify a link transition. Link transitions are actually short-duration assets that play when a button link is invoked, before the linked asset plays. In Hollywood discs, for example, when you click a button on the main menu to access a submenu, often the main menu "dissolves" into the submenu. This dissolve is achieved by playing a video asset that contains the transition frames. Typically, the transition frames are created in an application such as Adobe After Effects® or Adobe Premiere® Pro, where they're rendered as movie files.

Setting navigation and properties

Specify a link

Encore offers many ways to create and manage links. The Properties panel provides complete control over linking, letting you use menus or the pick whip to choose link destinations. You can also work with links in the element viewers and Flowchart panels. Generally, most users work with the Properties panel in conjunction with other panels (often Flowchart), using either the pick whip or menu selection as desired.

 *Choose Navigation Design from the Workspace menu to open the Adobe-designed workspace customized for navigation.*

Specify a link using the link menus

1. Select the element for which you are setting the link. For example, if you are setting the destination link for a button, you can select the button in the Menu Viewer or in the Menus panel.
2. In the Properties panel, choose a destination from the desired link menu (Link, End Action, or Override), and then choose the desired content from the submenu that appears (for example, a specific button, slide, or chapter). The link menus display up to 20 of the most recently used elements (such as menus, timelines, and slideshows). If the element you want is not listed, choose Specify Link (see below). Additional choices in the link menus include the following:

Link Back To Here Returns the viewer to the same destination.

Return To Last Menu Returns the viewer to the most recently accessed menu.

Resume Returns the viewer to the most recently viewed content (excluding menus), and plays that content from the point at which it was last viewed. A Resume button works well on audio and subtitle track selection menus, which viewers often access while viewing content.

Stop Stops playing.

Specify Link Lets you choose additional destinations not listed on the link menu, as well as change the audio and subtitle track. Select the desired link destination from the dialog box that appears, and then click OK. (To leave the default button unchanged, select the menu name rather than a button.)

Note: *Choosing Default rather than a specific button leaves the default button highlighted on the destination menu.*

3. If desired, specify a link transition, end action, and override.

 *You can also specify the link for a button by dragging the destination element (such as a slide in the Slideshow Viewer or a chapter in the Timeline Viewer) directly onto the button in the Menu Viewer or Menus panel.*

Specify a link using the pick whip

1. Select the element for which you are setting the link. For example, if you are setting the destination link for a button, you can select the button in the Menu Viewer or in the Menus panel.
2. In the Properties panel, drag the pick whip to the desired element, either in its viewer (such as the Timeline or Menu Viewer); the Timeline, Menu, or Project panels; or the Flowchart. When using the pick whip, you link to what you see—if you see only the element icon, you create a link to chapter 1 of the timeline, the first slide, or the default button of a menu; if you see the element's chapters or buttons, you can link directly to them. For example, to link to a specific chapter, drag the pick whip to the chapter marker visible in the Timeline Viewer. (Try creating different types of links by dragging to the same element in different panels, to get a feel for using the pick whip.)
3. If desired, specify a link transition, end action, and override.

Set disc properties and navigation

While most navigation deals with moving among the content on the disc, you must set a few disc-wide property settings and links.

1. To make the disc properties appear in the Properties panel, do one of the following:
 - Click in a blank area in the Project panel (such as the lower-left edge of the panel).
 - Choose Window > Build to open the Build panel. The Build panel also displays the disc properties in the Properties panel.
2. In the Disc Properties panel, enter a new name in the Name field. The default name is "Untitled Project."
3. For Description, type any notes about the project, such as client information, revision notes, and reminders.
4. Set the following options:

First Play Specifies what plays when you insert the DVD or Blu-ray disc into a player or open the Flash SWF file in a web browser. Often, the first play is an FBI warning or other copyright information. Encore automatically sets First Play to the first element you create in the project.

Override (Optional) Temporarily changes the end action of the element you chose for first play.

Title Button Specifies what displays when a viewer presses the Title button on the remote control. You generally set Title Button to return the viewer to the main menu of the disc.

Main Timeline Identifies the primary feature on the disc. The main timeline is the first timeline written to the disc and acts as the default timeline. For example, if viewers press Stop twice on the remote control, when they press Play again, the main timeline plays.

Set Audio (Optional) Sets the default audio track of the disc. No Change leaves the audio track as set in the player.

Set Subtitle (Optional; DVD and Blu-ray projects only) Sets the default subtitle track of the disc. No Change leaves the subtitle track as set in the player.

Buttons and navigation

The buttons on a menu are the primary navigation tool for the viewer. They control how the viewer steps through the project. Each button in a menu must lead to another menu, a timeline, a chapter, a playlist, a chapter playlist, or a slide show. You set the navigational links of a button and the optional end action override of that link in the Button mode of the Properties panel.

Note: *In addition to the linking options for all other assets, you can set a button link to Resume, which returns viewers to the point at which they accessed the menu.*

With the use of playlists or end action overrides, a button can control not just the next destination, but the subsequent destination as well. Therefore, with careful planning, you can dynamically change the path through the project according to what the viewer has just seen.

 *You can also specify the link for a button by dragging the destination element (such as a slide in the Slideshow Viewer or a chapter in the Timeline Viewer) directly onto the button in the Menu Viewer or Menus panel.*

Set button navigation

1. In the Menus panel, double-click the menu to open it in the Menu Viewer.
2. Select the button for which you want to set links. (Use the Selection tool , not the Direct Select tool, so that you select the entire button set.)
3. In the Properties panel, specify a destination for Link. Encore displays the new link in the Properties panel using the format Menu:Button or Timeline:Chapter. (For information on using the pick whip, see Specify a link.)
4. If you want to change the end action for the Link set in step 3, select a destination for Override in the Properties panel.

Set timeline navigation

Links from a timeline let you specify what plays next when the timeline finishes OR the viewer interrupts play.

1. In the Project panel, select the desired timeline.
2. In the Properties panel, specify a destination for End Action.
3. Select a destination for Menu Remote, which controls what is displayed when the viewer presses the Menu button on a remote control. You generally set this button to return the viewer to the last menu accessed, that is, the menu that brought the viewer to this timeline. You can do this easily by choosing Return To Last Menu from the Properties panel menu.

For information about the End Action link type or Menu Remote, see Project navigation and links.

Make global changes to elements and links

You use the element panels and the Properties panel together to manage links and make changes to elements. You cannot edit any fields directly in the panels. You can, however, select an element (such as a timeline in the Project panel or Timelines panel), and change its properties in the Properties panel.

You can make global changes to menus, buttons, or timelines using these tools together. For example, suppose the end action for several timelines points to the Main menu, and you now prefer these timelines to point to the Events menu. In the Timelines panel, you can select the timelines you want to change, and then reassign the end action to Events in the Properties panel. Encore changes the end action for all selected timelines.

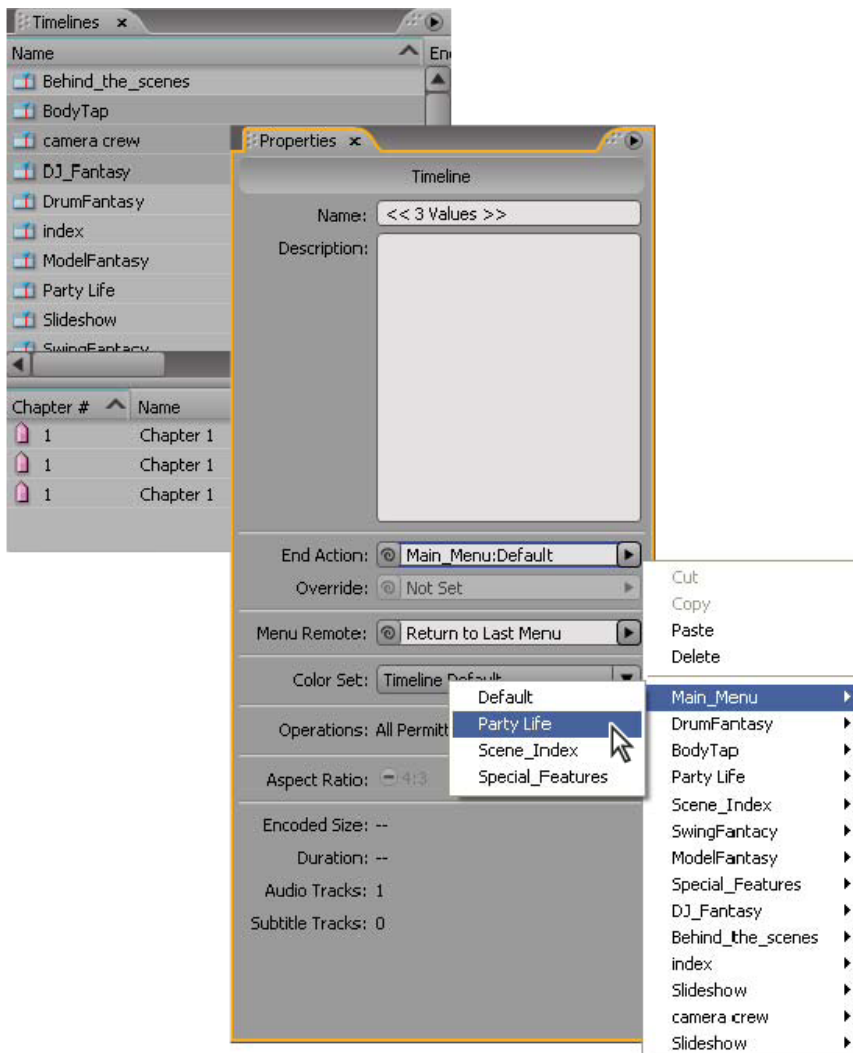

Selecting multiple menus, timelines, or buttons lets you make global changes to their properties.

1. Click the Project, Timelines, or Menu panel. (The Project panel displays all the elements in a project, while the Timelines and Menu panels only display the single element type.)
2. Select the desired elements. You can select only one type of element at a time. If you select different elements, such as a timeline and a menu, the Properties panel displays the message, "Objects of different types are selected." Note that you can select more than one menu at a time and that the buttons of all the selected menus appear in the lower panel.
3. In the Properties panel, change the settings or links as necessary. Encore resets the values for all the selected items. Properties that are not alike indicate the number of different values among the selected items (for example, "<<2 values>>").

More Help topics

[Build a DVD or Blu-ray disc](#)

[Check a project](#)

[Determining disc size](#)



[Legal Notices](#) | [Online Privacy Policy](#)

The Flowchart panel

- [Flowchart overview](#)
- [Flowchart thumbnails](#)
- [Flowchart tools](#)
- [Set navigation in the Flowchart](#)
- [Add elements to the Flowchart](#)
- [Change links and properties in the Flowchart](#)
- [Rearrange items in the Flowchart](#)
- [Jump from the Flowchart to other viewers](#)

Flowchart overview

[To the top](#)

The Flowchart provides a graphic interface that lets you complete many common authoring tasks. You work with the Flowchart throughout the project, oftentimes in conjunction with other panels—notably the Properties panel. You can efficiently accomplish all of the following tasks in the Flowchart:

- Create and update project navigation by visually arranging and linking elements.
- Update properties quickly and easily for an element.
- Quickly identify navigation problems such as orphaned elements and broken links.
- Drag from Windows Explorer or the Mac OS Finder or the Encore Library panel to automatically add items to the project as elements.
- Open an element in its viewer panel to edit it.

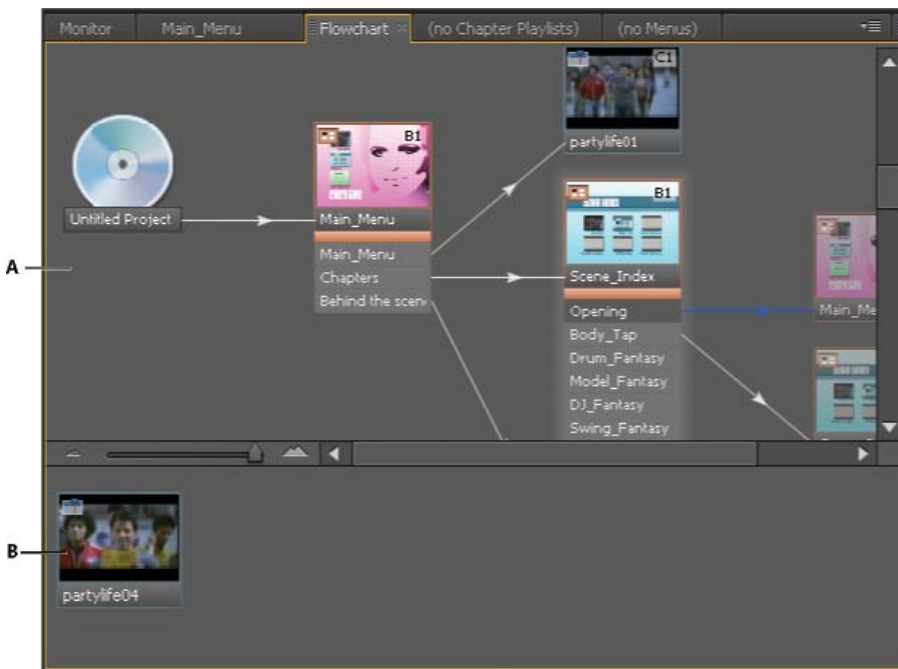

Flowchart displays project's current structure in upper portion (A), and unused, or orphaned, elements in bottom portion (B).

The Flowchart provides several visual clues about items and their links. The disc icon represents the root of the hierarchy. Each item in the Flowchart can include a thumbnail that informs you of the element type (slide show, timeline, and so on), its buttons (for menus), audio and subtitle track information, and the chapter being linked to (for timelines, slide shows, playlists, and chapter playlists).

The lines joining the element thumbnails also convey useful link information. By noting the line style, you can differentiate between normal links, links that have been overridden, and other useful link attributes.

 For a video tutorial about using the Flowchart, see www.adobe.com/go/vid0240.

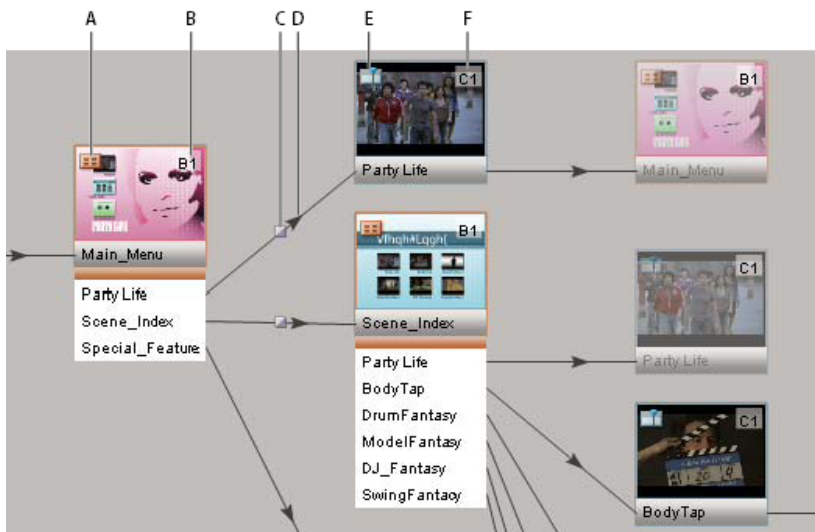

Quick glance at section of Flowchart: Main Menu's thumbnail shows that it's a menu, indicated by its type icon (A), with default button set to Party Life, indicated by its info badge (B). Party Life button invokes link transition, indicated by link transition icon (C), before it plays Party Life, indicated by arrow (D). Party Life, which is a timeline, indicated by its type icon (E), begins playing from chapter 1, indicated by the info badge (F).

[To the top](#)

Flowchart thumbnails

Thumbnails provide visual clues about elements and links. Elements in the Flowchart display thumbnails by default. A given element can appear numerous times in the Flowchart, depending on its links. For the first occurrence of an element, the original, the element appears at full opacity. Additional occurrences of an item, or its aliases, appear at 50% opacity. Original menus include buttons.

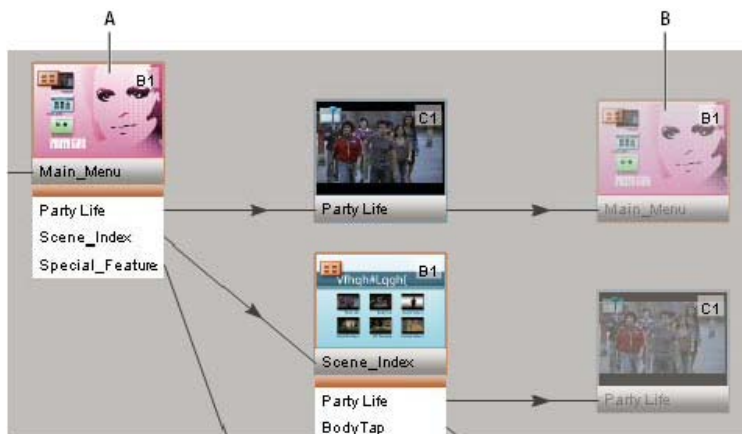

Button (A) links to timeline with end action linking back to menu. Menu appears twice, once as actual element (A), and once as alias (B).

Items used in the project, linked by using some path to the disc icon, appear in the upper pane of the Flowchart. Unused items appear in the lower pane of the Flowchart. When you place the mouse pointer over them, the tool tip shows the name of the asset.

Thumbnails also include type icons and info badges, and are joined with link lines.

Zoom in and out

You can zoom in and out the flowchart view to the relevant parts of the flowchart. Use the slide bar at the bottom of the Flowchart panel or the Zoom tool.

Zoom in Do one of the following:

- Slide right the slide bar on the Flowchart panel.
- Select the Zoom tool and click the Flowchart panel.
- Select the Zoom tool and click-drag on the Flowchart panel.

Zoom out Do one of the following:





- Slide left the slide bar on the Flowchart panel.
- Select the Zoom tool and Alt-click on the Flowchart panel.

Toggle the display of thumbnails

You can specify whether thumbnails appear in the Flowchart.

❖ Choose Show All Thumbnails from the Flowchart panel menu.

Type icons

The icon in the upper left corner of an object's thumbnail denotes the type of item: Menu , Timeline , Playlist , Chapter Playlist , or Slide Show .

Info badges

The info badge in the upper-right corner of an item's thumbnail details certain attributes, depending on the type of item. (The audio and subtitle track badges actually denote tracks specified by the incoming link, not attributes of the item.) The labels on an info badge denote the following attributes:

None Default button is set to none.

B[n] Default button is set to button [n].

BA Default button is set to the active audio track.

BS Default button is set to the active subtitle track.

A[n] Audio track is set to audio track [n].

S[n] Subtitle track is set to subtitle track [n].

SX Subtitle track is off.

C[n] Link to chapter [n].

Link lines

The appearance of link lines informs you of the relationship between elements, and the arrow indicates the direction of the link.

Solid black lines Represent a normal link.

Red lines Represent a broken link. A broken link means that the destination of the link has been changed indirectly (by some action other than specifying the link), and is no longer valid. For example, if you delete the element to which a link points, the link appears as broken.

Blue lines Indicate that the object the link originated from is selected. When you select a broken link, the line remains red, but the arrow appears blue.

Dashed lines Indicate a link overridden by a prior object. The dashed link will not be followed in this location—the end action override of the prior object is followed.

Double-headed arrows Indicate an override end action returning to the original item.

Transition icon  Indicates a button link with a transition.

Flowchart tools

[To the top](#)

Selection tool Functions as a link tool, or a pick whip. Drag from an object in the Flowchart to another object, inside or outside of the Flowchart, to set a link to the target item.

Direct Select tool Functions as a drag-and-drop tool. Drop an item from anywhere, including Windows Explorer or the Mac OS Finder, onto an item in the Flowchart to set an outgoing link from the target item to the dropped item. (Dropping items from Windows Explorer or the Finder automatically imports the asset and converts it to an Encore project element.)



Move tool Moves manually placed items in the Flowchart (aliases can't be moved). You can also convert automatically placed items to manually placed items by dragging them with the Move tool. The Move tool does not set any type of link.

Set navigation in the Flowchart

[To the top](#)

For smaller projects, you can drag items directly into the Flowchart panel and arrange them manually. For large, complex projects, you can use auto layout, letting Encore position items in the Flowchart. You can also choose to work with a combination of auto and manual layout.

 *Use the Navigation Design workspace when you create and manage links. Choose Window > Workspace > Navigation Design to open the predesigned workspace.*

1. Create a new project, and then import and convert the necessary assets into Encore project elements. In this example, the project includes a main menu, a timeline, and a slide show.
2. Choose Window > Flowchart if you don't see the Flowchart panel. The first element you imported is already linked to the disc icon. (Encore automatically sets the project's First Play link to the first imported element.) The remaining, unused elements appear in the lower section of the Flowchart panel.
3. Set the desired First Play link. In this example, the First Play item is the main menu. Set this link using one of the following methods:
 - Click the Selection tool , and then select the disc icon. (The Selection tool icon changes to the pick whip icon  when it's in the Flowchart.) Drag from the disc icon to the element you want to set as the First Play link. You can drag to other items in the Flowchart, or to the Project, Timelines, or Menus panel.

- Click the Direct Select tool , and drag an item from anywhere, including Windows Explorer or the Mac OS Finder, onto the disc icon.
 - Right-click (Windows) or Control-click (Mac OS) the disc icon and choose Specify Link from the context menu. In the Specify Link dialog box, select the main menu and click OK.
4. Create a link from the menu's first button (listed under the main menu icon) to the timeline (displayed in the lower section of the Flowchart panel) by using one of the methods in step 3.
Note: *Original menu icons in the Flowchart display a list of the buttons they contain, menu aliases do not.*
 5. Set the end action of the timeline you just added to target the slide show using one of the methods in step 3. After you set the link, note that, in the timeline's Properties panel, the end action links to the slide show. When the viewer selects the first button, the timeline plays and then the slide show.
 6. Set the menu's second button to link directly to the slide show using one of the methods in step 3. Now the viewer can go directly to the slide show, skipping the timeline, by clicking the second button on the menu.
 7. Save the file.

Add elements to the Flowchart

[To the top](#)

The Flowchart links elements you add depending on where you drop them. If you drop an element (such as a timeline, menu, slide show, and so on) onto empty space, no link is created. If you drop an element onto a menu thumbnail, a new button is created, linking to the element. If you drop an element onto a menu's button, a link from the existing button to the element is created. If you drop an element onto a timeline, slide show, playlist, or chapter playlist, an end action linking to the dropped element is created. Linking assets by using the pick whip behaves in the same way.

❖ Do any of the following:

- Drag an unused element from the lower pane onto an element in the upper pane to add it to the Flowchart.
- Drag an element from the Project panel to the Flowchart.

Note: *If you can't drag a file from the Project panel, make sure it's been converted to an element type. For example, you can't drag a movie file, but you can right-click (Windows) or Control-click (Mac OS) the movie file, choose New Timeline, and then drag the resulting timeline to the Flowchart.*

- Drag the pick whip from an element in the active panel to another element. The target element may be in the unused panel or the project panel. Encore adds the element to the Flowchart and links it appropriately.
- Drag a file (or multiple files) from Windows Explorer or the Mac OS Finder, or an item from the Encore Library panel, to the Flowchart. Encore places the item in the Flowchart, creating an Encore element from the imported asset or library item.

Change links and properties in the Flowchart

[To the top](#)

You can use the Flowchart in tandem with the Properties panel to change links or other properties of an element.

Edit links in the Flowchart

1. Select the element whose link you want to modify.
2. In the Properties panel, drag the pick whip from the Link field to the element representing the new link destination.

Encore updates the link and refreshes the Flowchart panel appropriately.

 You can also manage links by dragging. (See *Set navigation in the Flowchart.*)

Change asset properties in the Flowchart

❖ Select an item and modify its settings in the Properties panel. When you change an object's properties, all aliases of that object in the Flowchart change.

Rearrange items in the Flowchart

[To the top](#)

Encore automatically populates the Flowchart as you create elements and link them together. You can also add items to the Flowchart manually, by dragging. Manually placed items include a drop shadow for easy identification. You can move both manually and automatically placed items or let Encore rearrange manually placed items automatically. The distinction between manually and automatically placed items applies only when working in the Flowchart. The layout state of an object (auto or manual) does not influence links or any other object attribute.

Move items in the Flowchart

❖ 

Select an object using the Move tool and drag it to a new location. You cannot change the position of an alias. When you move an element manually, any automatically placed elements attached to it move along with it.

Rearrange items automatically

❖ In the Flowchart, do one of the following:

- To automatically rearrange a single item, right-click it (Windows) or Control-click it (Mac OS) and choose Auto-Layout from the context menu that appears.
- To automatically rearrange all the manually placed items, choose Auto-Layout All from the Flowchart panel menu.

Jump from the Flowchart to other viewers

[To the top](#)

From the Flowchart, you can open elements directly into their corresponding viewer, start Project Preview, or open a menu to edit it in Adobe Photoshop®.

❖ In the Flowchart, do any of the following:

- Double-click a timeline, menu, chapter playlist, or slide show to open it in its viewer.
- Right-click (Windows) or Control-click (Mac OS) any element and choose Preview From Here to start previewing from that point.
- Right-click (Windows) or Control-click (Mac OS) a menu and choose Edit Menu In Photoshop to automatically start Photoshop and open the menu in it.

More Help topics

[Using the Flowchart video](#)

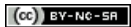

[Legal Notices](#) | [Online Privacy Policy](#)

Viewer interaction through the remote control

[About user operations](#)
[Disable or edit user operations](#)

About user operations

[To the top](#)

User operations are the interactions a viewer has with your project using the remote control. You can disable user operations to prevent the viewer from making an inappropriate choice. For example, you can disable user operations to prevent the viewer from fast-forwarding through the FBI warning.

You can disable user operations for a disc, its timelines, and its menus. The operations you can disable vary, depending on the asset. For example, you can disable the Previous and Next chapter buttons for a timeline, but not for a menu, because that operation applies only to timelines.

Disable or edit user operations

[To the top](#)

1. Do one of the following:

- Choose Timeline > Set Timeline User Operations.
- Choose Menu > Set Menu User Operations.
- Choose File > Set Disc User Operations.
- In the Project panel, select a timeline or a menu, or click in a blank area to select the disc properties, and then click the Set button in the Properties panel.

***Note:** Disabling user operations at the disc level disables that operation in DVD elements too. You can, however, enable a function at the disc level and then disable it for specific menus, timelines, and other elements.*

2. In the User Operations dialog box for the timeline, menu, or disc, select All, None, or Custom, and the desired options. Then click OK.

Custom options for timeline user operations

Play Timecode Lets the viewer enter a timecode to play or search for.

Stop Lets the viewer stop playing the disc.

Rewind/Fast Forward Lets the viewer rewind and fast-forward the disc.

Pause Lets the viewer pause the disc.

Previous/Next Chapter Lets the viewer move among chapters.

Search For Chapter Lets the viewer search for a specific chapter.

Title Remote Lets the viewer use the Title button on the remote control.

Menu Remote Lets the viewer use the Menu button on the remote control.

***Note:** Blu-ray Disc players (and remote controls) do not support the Menu Remote setting for a timeline.*

Change Presentation Mode Lets the viewer set the playback mode to 4:3 or 16:9.

Change Audio Tracks Lets the viewer change audio tracks while content is playing.

Change Subtitle Tracks Lets the viewer change the subtitle track when content is playing.

Custom options for menu user operations

Stop Lets the viewer stop playing the disc.

Resume Lets the viewer resume play from where content was stopped.

Title Remote Lets the viewer use the Title button on the remote control.

Change Presentation Mode Lets the viewer set the playback mode to 4:3 or 16:9.

Arrow And Enter Keys Lets the viewer use the arrow and Enter keys on the remote control.

Custom options for disc user operations

Play Timeline Lets the viewer enter a number of a timeline to play.

Change Presentation Mode Lets the viewer set the playback mode to 4:3 or 16:9.

Play Chapter Lets the viewer play a specific chapter.

***Note:** Disabling Play Chapter also disables the Search For Chapter operation.*

Search For Chapter Lets the viewer search for a specific chapter.



[Legal Notices](#) | [Online Privacy Policy](#)

Testing and building the final product

Building the finished project

[Build a DVD or Blu-ray disc](#)
[Specify a layer break for dual-layer DVDs](#)
[Replicating discs](#)

[To the top](#)

Build a DVD or Blu-ray disc

After you complete, preview, and set transcoding options for your project, you can burn it to a disc or build to an image ready for burning or replication. You can build the same project to DVD and Blu-ray formats no matter which format you select in the New Project or Project Settings dialog box. Encore makes the appropriate adjustments to transcode the elements to the correct format.

If you had imported assets that were Blu-ray compatible, Encore doesn't transcode these assets during build. If you have problems while building a Blu-ray Image output, transcode the assets with a different preset before building the Blu-ray Image output again. See [Supported file formats for import](#).

Note: *All clips on a track must have the same frame rate. Ensure that the audio and video durations match on all tracks on a Blu-ray Disc project. If the timeline in your project has audio tracks longer than the video track, you cannot burn a Blu-ray disc. Trim the audio track to make it shorter than the video track.*

You can also use the Build panel to export your project to a Flash format for interactive viewing on the web. (For information, see [Exporting projects to Flash format](#).)

Encore checks for problems before building the disc. If the program encounters errors, it notifies you and lets you view the errors or continue. For more information, see [Check a project](#). For a video tutorial on building your project to DVD, Blu-ray Disc, or exporting to Flash, see <http://www.lynda.com/home/Player.aspx?lpk4=65355&playChapter=False>.

1. If you are going to burn directly to a disc, make sure that you have blank media in the appropriate drive.

Note: *[Mac only] Set the system preferences to ignore the blank DVD warning before you insert the DVD in the drive. If you haven't done that before inserting the DVD, choose ignore from the Action pop-up menu. Do not mount the blank DVD.*

2. Choose Window > Build.

 You can also choose File > Build, and then choose an Output option from the submenu.

3. In the Build panel, choose either DVD or Blu-ray from the Format menu.

4. Choose an option from the Output submenu:

DVD Disc Or Blu-ray Disc Burns a disc to play on set-top Blu-ray or DVD players, computers, or game consoles. You can record to a Blu-ray disc in a Blu-ray Disc burner and to a DVD in a DVD-writable drive.

DVD Folder Or Blu-ray Folder Builds a Blu-ray or DVD directory structure on your hard drive for quality assurance or local playback on a computer. You can play the program using a DVD or Blu-ray software player and the directory behaves just like a disc, including having full navigational abilities.

DVD Image Or Blu-ray Image Builds a Blu-ray or DVD image on your hard drive. The image is typically used for local replication by using a third-party mastering application.

DDP Image (for DVD) Writing to a DLT requires extra hardware. A DDP image can be directly exported to your computer's hard disk, and electronically delivered to the replication facility using FTP. Delivery through electronic media is faster, and does not involve the extra hardware associated with DLT.

5. Specify the source (such as the current project), the destination (such as the disc recorder drive), and any other appropriate settings. The settings are different depending on the Output option you choose.

6. Click Build.

7. Save the project if prompted.

8. If you have any problems in your project, you are prompted to manage them or ignore them. Adobe recommends that you fix all problems, and then click Build again.

9. When writing is complete, click OK.

Blu-ray and DVD build settings

The Build panel includes three sections—Source, Destination, and Disc Info—that are common to Blu-ray and DVD formats. Additional sections for DVD Settings include DVD-ROM Content, Region Codes, and Copy Protection.

The options in these sections vary, depending on the format and type of output you choose:

Source Specifies which project to use for the build:

Create Using The current project appears by default if you are building your working project. Other options include DVD Volume, to specify a DVD project you've already built to a folder; and Disc Image, to specify a Blu-ray or DVD project you've built to an image file on your hard drive. Click Browse to locate and specify the project.

Destination Specifies where to write your project:

Location For output to Folder or Image, specifies the destination for your build folder or disc image. Click Browse to specify the location.

Recorder For output to Disc or DVD Master, specifies the disc writer or DLT drive to which the project is sent for burning. Click Refresh to scan your hardware for additional recorders.

Test Before Writing Tests the recorder, not the project, before burning the disc. To test the project, see Check a project.

Write Speed Specifies how fast the selected recorder writes to the disc. Encore displays the maximum speed of the drive you selected. You can select a lower speed.

Number Of Copies Type the number of discs to burn. If you choose to burn multiple copies, Encore prompts you to insert new discs when needed.

Auto-Erase Rewritable Discs Erases rewritable discs that already contain data before the program writes the new data. Selecting this option bypasses the alert message that normally appears later in the process.

Disc Info Displays the amounts of free and used disc space for the current project. (For more information, see Check the space remaining on your disc.)

For Blu-ray Disc image output, Disc Info also includes the following Image Type options:

BD-R Image Type Write-once, recordable format for high-definition TV recording and computer data storage

BD-RE Image Type Re-writable format for high-definition TV recording and computer data storage

BD-ROM Image Type Read-only format for computer software, games, and movie distribution

For DVD output, Disc Info also includes the following settings:

Name The name entered in the Disc Properties panel appears here. To change the disc's name, enter a new one.

Note: For Blu-ray Disc output, Encore uses whatever name you specify in the Disc Properties panel.

Size Defaults to last size used. To change the disc size, select a size from the pop-up menu. If you choose Custom, you must also enter the desired size in the Custom box.

Side Select One or Two to specify the side of a dual-sided DVD. (For more information, see Determining disc size.)

Layer Break Specifies whether the layer break for dual-layer DVDs is set automatically by Encore or manually.

DVD-ROM Content Specifies the source location of the folder containing ROM content. (This setting also applies to Blu-ray discs even though it is not listed under Blu-ray settings.) For information, see Add ROM content to the disc.

Region Codes Specifies regions allowed for viewing the DVD. Region codes must be enabled by a professional replicating facility. (This option is not available for Blu-ray discs.) For more information, see Set region coding for replicated DVDs.

Copy Protection Specifies a choice of different forms of copy protection that can be set during professional replication of the DVD. (This option is not available for Blu-ray discs.) For information, see Set copy-protection for replicated DVDs.

AVCHD passthrough

Encore does not transcode Blu ray legal (as per BD spec) AVCHD files (MTS,M2TS) when building a blu ray.

Frame Size	Display Aspect Ratio	Frame Rate	Scanning Method	Video Formats	
				NTSC	PAL

720 × 480	4x3	29.97	Interlaced	Yes	
720 × 480	16x9	29.97	Interlaced	Yes	
720 × 576	4x3	25	Interlaced		Yes
720 × 576	16x9	25	Interlaced		Yes
1280 × 720	16x9	23.976	Progressive	Yes	Yes
1280 × 720	16x9	50	Progressive		Yes
1280 × 720	16x9	59.94	Progressive	Yes	
1440 × 1080	16x9	23.976	Progressive	Yes	Yes
1440 × 1080	16x9	25	Interlaced		Yes
1440 × 1080	16x9	29.97	Interlaced	Yes	
1920 × 1080	16x9	29.97	Interlaced	Yes	
1920 × 1080	16x9	25	Interlaced		Yes
1920 × 1080	16x9	23.976	Progressive	Yes	Yes

[To the top](#)

Specify a layer break for dual-layer DVDs

Dual-layer DVDs must have a *layer break*—the point at which the DVD player switches from the first layer to the second. Ideally, Encore creates the layer break (also called *layer transition*) between timelines or menus, making a smooth transition (since it jumps layers at a point where no content is playing). If it cannot find a spot that satisfies these requirements, Encore enables the Layer Break setting. When the Layer Break setting is enabled, you can specify the break manually, or let the software do it automatically.

Note: This option is not available for Blu-ray discs.

1. Choose File > Build, and choose the option corresponding to the type of DVD output to build.
2. In the Disc Info section of the DVD Settings, make sure the disc's Size is set to 8.54 GB Dual Layer.
3. If the Layer Break setting is enabled, specify the type of layer break:

Automatic Lets Encore determine the layer transition. To use an existing break, check If Possible, Use Existing Layer Break. If no valid break exists, the program uses the last chapter point in the allowable range. If no chapter point exists, Encore uses the midpoint of the range (per the timecode) as the default location.

Manual Opens the Set Layer Transition dialog box. Set the layer break at either a chapter point or a specific frame (per the timecode.) Encore lists the choices for each option. Creating a layer break at a chapter point can result in a brief pause as the DVD player moves from one layer to the next.

[To the top](#)

Replicating discs

To produce multiple copies of your DVD or Blu-ray disc, you can burn them yourself, either in Encore or by using a third-party mastering application. Producing them in Encore works best for limited quantities and requires the appropriate hardware or software. However, if you require a large quantity of discs, use a professional replication facility for mass production. Most replication facilities can accept files in DLT format or as single-layer DVD images (without copy protection applied). For specific information, contact your replication facility.

Note: DVDs that use copy protection or region coding must currently be replicated at a professional replication facility. (The replication facility collects royalties.) If you burn these types of DVDs from Encore, the resulting discs work, but they do not include copy protection or may not include region coding. For information on region coding, see Set region coding for replicated DVDs. For information on copy protection, see Set copy-protection for replicated DVDs.

Exporting projects to Flash format

- [How export to Flash works](#)
- [Export your current project to Flash](#)
- [Tips for creating Flash projects](#)
- [Embed web links in your Flash project](#)
- [Play Flash DVD output files](#)
- [Use HTML templates](#)
- [Set up a local FMS server](#)
- [Add a streaming server](#)

How export to Flash works

[To the top](#)

You can export your Encore project either for local use (all files present locally) or to a webserver (video files present on streaming server).

In both cases, you specify the folder in which the output is stored. Encore creates the following files and a folder that contains the generated output:

flashdvd.swf

The SWF file enables the browsers or Flash players to play the video content that you upload to a server. The flashdvd.swf file does not contain the actual video—it is, instead, a front end for the generated video output. The flashdvd.swf file reads the AuthoredContent.xml file and plays the Flash output accordingly and remains static even when your video has changed.

AuthoredContent.xml

This XML file contains the information about the video output files such as filenames, association of videos with menus, and navigation. You update this XML file when your video files or the menu structure change. If you choose to upload your Flash output to a server, the URLs of the videos are updated in this file.

index.html

The HTML file that hosts the flashdvd.swf file. This file gathers the required information about the first play setting and menu structure from the AuthoredContent.xml file.

Sources folder

This folder contains the Flash videos and the menu images and icons. The Flash video files are either FLV or F4V format, based on your choice.

If you are publishing the video directly to the web server, Encore updates the *AuthoredContent.xml* file with the URLs for the assets received from the server. In this process, all video files (FLV and F4V) are uploaded to the server.

If you do not have access to a server, choose the Keep With Flash SWF option in Encore's Build panel. The FlashDVD content is saved in the specified destination folder. Because your video now resides in the local or a shared network folder, the *AuthoredContent.xml* file contains the relative path to the Sources folder.

Typically, you host the video files on a Streaming server and host the other output files (Sources, AuthoredContent.xml, Theme.xml, index.html) on a web server.

You can choose one from the fifteen export quality presets that provide you five frame sizes, each with three quality presets: Low, Medium, and High quality. Of the five frame sizes, two are standard size and the remaining are widescreen formats. In Addition to system presets, now you can create custom presets of different frame sizes with different quality settings from Edit Quality Presets from Build panel. For a video tutorial on exporting your project to Flash, see <http://tv.adobe.com/watch/adobe-evangelists-jason-levine/authoring-a-flash-based-dvd-for-the-web/>.

Export your current project to Flash

[To the top](#)

1. Choose Window > Build. If you haven't checked your project for broken links or specified the First Play setting, click Check Project in the Build panel. (See Check a project.)
2. In the Build panel, choose Flash from the Format menu. The settings Output: Flash (.swf) and Source: Current Project are automatically selected.
3. Specify the destination for the exported Flash video files by typing the location file path or clicking Browse to enter the location.

4. Under Settings, type a name for the project folder and choose the file format from the Format menu.

5. Select the preset from the list.

Note: The choice of quality preset doesn't significantly affect the build time. Select the preset that suits your intended use of the Flash output. Use small frame size and low resolution presets to output the smallest version of the project for e-mail. Use large frame size and high quality presets for delivering content across faster networks at broadband data rates or on a local area network (LAN). Reserve the largest frame size and high quality presets for playback from a local computer, or a dedicated data server or shared hard drive.

6. Select Do Not Export Images for Text Subtitles if you want Encore to export text subtitles only in the text format. If you do not select this option, Encore exports subtitles as both images and text.

The images are usually used for text display, and the text is used for searching the subtitles. When you export subtitles as text only, the text is used to display subtitles too.

When you export subtitles as text, any properties that you have set for the text are lost. Customize the Subtitle tag in the Theme.xml file to set the properties for the text subtitles at runtime.

```
<Subtitle>
  <Font name='Tahoma' size='18' color='0xFFFFFFFF' bold='false' italic='false'
underline='false' bullet='false' align='center' /> <!--If font is not available in system
it will fall back to "Times New Roman" on windows and "Times" on Mac OS X -->
</Subtitle>
```

7. Select the HTML template. Do one of the following:

- Select the template from the list of available templates.
- Click Import Template to import the template that you want to use.

- To delete a template, select the template from the list of available templates and click Delete Template. You can delete only those templates that you have created.
- To preview the template, select the template from the list of available templates and click Preview Template.

8. Select the type of Flash media delivery from one of the following options:

Keep with Flash SWF

The Flash video file is downloaded progressively to the viewer's computer and played at the same time. The downloaded Flash video file remains in the user's computer. Content of an FLV or F4V file exported from Encore can buffer a portion of the currently playing FLV or F4V file. The buffering helps in smoother playback when the bandwidth is low.

Upload to Server

The Flash video file is played on the user's computer from the server.

Server

If you selected Upload To Server, select the server where you want to upload the file.

9. Click Build.

The output of the build is a folder with FlashDVD content. You can post this folder on your web server for accessing over the Internet, or you can open the index.html file in a browser to play the media.

If your login is successful, Encore uploads the video files (FLV or F4V files) in the Sources folder to the server. The AuthoredContent.xml file stays in the Destination folder.

Note: Adobe recommends posting Flash output to a webserver. Security settings on some local machines can prevent playing the video in these machines.

Tips for creating Flash projects

[To the top](#)

Keep in mind the following tips as you plan your projects for interactive viewing on the web:

1. You can create web links to other areas in your website when a viewer clicks a button in the Flash output, or when a timeline or motion menu reaches the end of playing.
2. You can use high-definition and standard-definition assets in your Flash projects.
3. Flash does not support playing from multiple audio tracks in a timeline. Flash output does not support user operations.

Embed web links in your Flash project

[To the top](#)

You can use a menu element to create a link from Flash output to an external URL on the web. When viewers click a button that goes to that menu element, instead of seeing a menu display, they see the web page of the specified URL.

Note: Unless you set up privileges in Flash Player, the URL must be in the same domain as your Flash project.

- Do one of the following:
 - Select a button in a menu and select Enable Weblink For Flash, and then enter a URL.
 - Select the new menu (in the Project panel or the Menus panel), and in the Properties panel, Enter URL as http://www.adobe.com where www.adobe.com is your URL.
- The button can also link to an object such as a timeline, slide show, menu, or a playlist. This link is used when you export your project to DVD and Blu-ray. You can ignore the button link when "Enable Weblink for Flash" is selected and the URL is provided.

Play Flash DVD output files

[To the top](#)

1. Double-click the index.html file that is generated in the project folder when you build a Flash project. The file opens in your default web browser.

Playback for slideshows in Flash DVD is seamless.

Note: You should use Flash Player 11 or higher to play Encore web DVDs.

The toolbar has various controls using which you can perform various actions on the movie.



Controls in the Encore Flash DVD player

A. Previous chapter **B.** Step backward **C.** Play/Pause **D.** Step forward **E.** Next chapter **F.** Progress bar **G.** Elapsed time/Total time **H.** Search **I.** Title **J.** Last menu **K.** Pop-up menu **L.** Subtitle **M.** Mute **N.** Volume **O.** Full screen

Previous Chapter/Next Chapter

Enables you to move among chapter points in the movie.

Step Forward and Step Backwards

Enables you to have a quick preview of the video. With each click, the video skips 5 seconds, and resumes playback from the new location.

Play/Pause

Toggle this button to play or pause the movie.

Progress bar

Lets you “seek” through the length of the video. You can drag the seek bar to move across the frames in the video. When a movie is searched, red bars appear in the progress bar corresponding to scenes containing the search terms.

Elapsed time/Total time

Displays the duration for which the video has played, and the total time.

Search

Helps you search the contents of the movie being played.

Title

Displays the title of the movie.

Last menu

Displays the menu that you visited previously.

Pop Up Menu

Displays the menu of the movie. Clicking the button again stops the menu display. Creating pop-up menus for Flash DVD is the same as that for blu-ray discs.

Subtitles

Displays subtitles on the screen. Click Subtitles, and select from the languages available in the menu. Click Off to turn stop subtitle display.

Note: The options last set for subtitles are used when you play the movie again. When you play a movie for the first time, the subtitles in the first track are used.

Mute

Toggle this button to mute/unmute a phone.

Volume

Use this control to increase or decrease the volume of audio in the movie being played.

Full Screen

Displays the movie in the full screen mode. Users must press Escape to exit this mode. All controls are available in the full screen mode, and fade away when the screen is left inactive for some time.

Keyboard shortcuts for Flash DVD player

Action	Keyboard shortcut
Play/Pause	Spacebar
Previous chapter	P
Next chapter	N
Step forward	Ctrl + Right Arrow
Step backward	Ctrl + Left Arrow
Search	Ctrl+F
Title	Home

Last menu	Backspace
Subtitle	Ctrl + S (Mac), Ctrl+Shift+S (Windows)
Volume	+/-
Full screen	F/Esc
Mute	M (toggle)

Customize appearance of playback controls

When you build an Encore project in Flash, a Theme.XML file is created at the location of the build. Configure the contents of the file to customize the appearance of playback controls in the Flash DVD display. The process for customizing the controls is available within the file itself. For example, you can customize the properties of the search bar using the SearchBar tag. <SearchBar show='true'> <Color background='0xB3B3B3' /> <NextButton show='true' /> <PreviousButton show='true' /> </SearchBar>

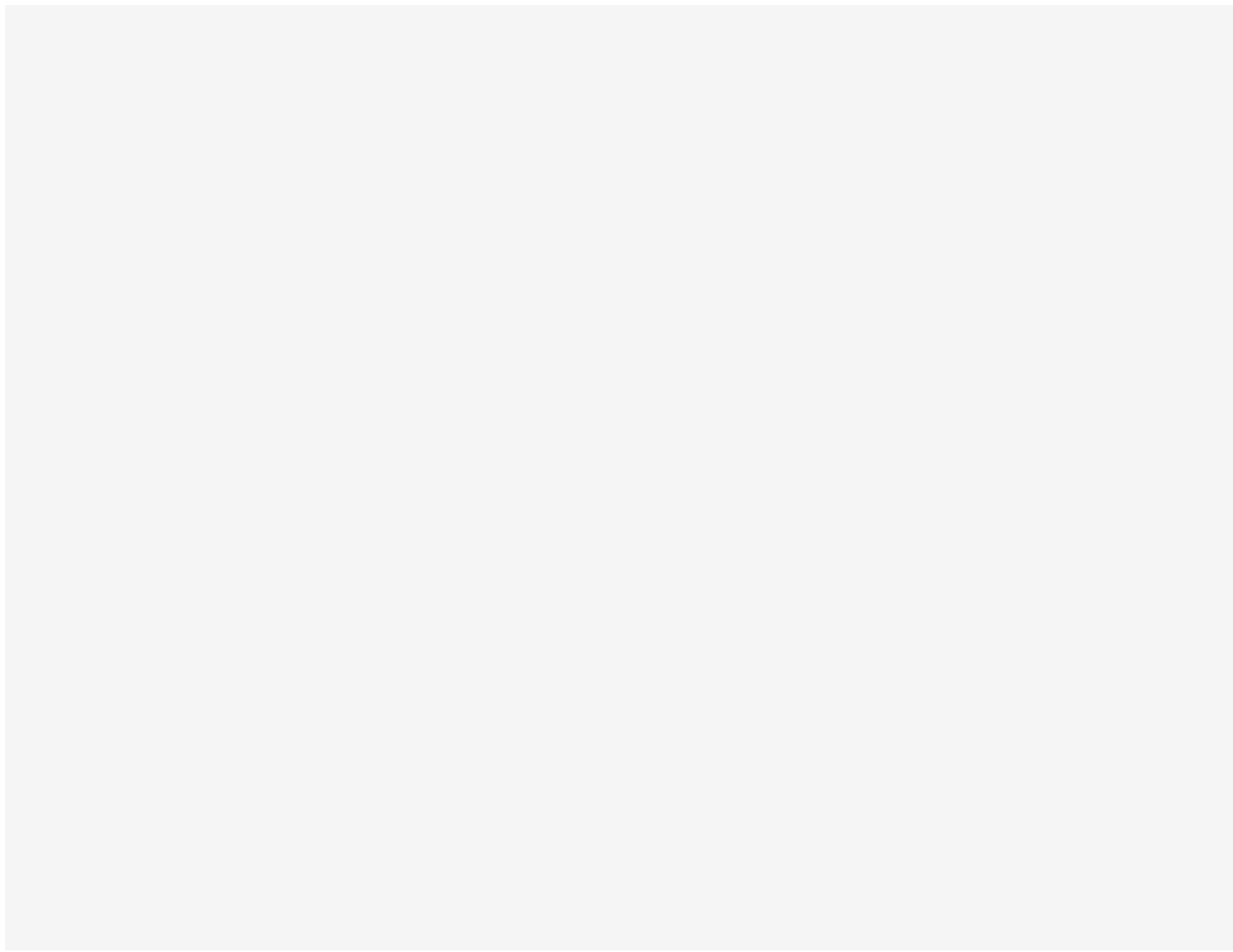

```
<SearchBar show='true'>
  <Color background='0xB3B3B3' />
  <NextButton show='true' />
  <PreviousButton show='true' />
</SearchBar>
```

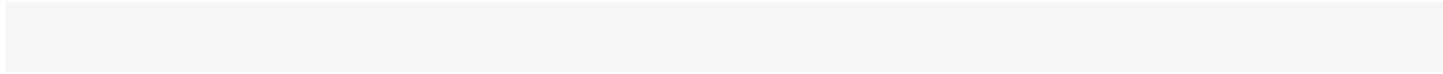

Search content in Flash DVD

You can search for the following types of content when playing a movie in the Flash DVD player:

Subtitles

You can search subtitles in timelines, slideshows, playlists, and chapter playlists.

Note: Only subtitles containing text are searched. FAB image subtitles do not generate a text output, and so, cannot be searched.

Speech transcripts

Search text in speech transcript metadata of clips in a Timeline.

Note: Speech Transcript for a clip can be generated from Premiere Pro using its Speech- to- Text metadata feature.

Names of menu buttons as set in the property panel

The search generates a list of scenes and menus containing the search terms. When you click a scene or menu in the list, the movie starts playing from that scene or menu.



Search field in the Flash DVD player in the browser

A. Search results B. Progress bar with results C. Search field

Red and blue lines appear in the progress bar at places corresponding to the search results in the list when the movie plays. Red lines indicate search results from speech transcripts, and blue lines, from subtitles. Click a line in the progress bar to start playing a movie from that scene or menu.

1. Build an Encore project in Flash. The project can contain menus with buttons, timelines containing clips with transcript metadata, subtitles, or slide shows.
2. Open the generated HTML file in a browser.
3. Click the Search button in the SWF movie player controls.
4. In the Search field, enter the text that you want to search.
5. Press Enter. A list of scenes and menus containing content matching the search terms is displayed.
6. Do one of the following:
 - Click a scene in the list. The movie starts playing from that scene.
 - Click a red or blue line in the progress bar to play the movie from that scene. The lines in the progress bar appear only when the movie plays in the browser.
 - To play successive scenes in the list, click Next. To play previous scenes in the movie, click Previous.
7. To clear the search list and the red lines in the progress bar, click the Clear (X) button in the search field.

Note: Click the heading row of the column to sort the column.

Subtitles in Flash DVD

When you build an Encore project in Flash format, the subtitles in the project are also exported. The Flash DVD player searches Subtitles that are

in the text format. Image subtitles are not searched.

[To the top](#)

Use HTML templates

You can add backgrounds to Flash export using templates. For example, rather than playing against a standard black background, your project plays in a frame or against a background image that reflects the motif of menus or chapter icons. You can create HTML templates and then import them to your project.

You can create your own templates and import them into Encore. A template consists of a folder containing an index.html file as well as other content referenced by index.html. Your index.html can contain HTML tags in addition to tags supported by Encore. When you export your project to Flash format, these tags are replaced with SWF content, and the video is placed at the location of the tag in the HTML file. Encore looks for the following supported tags in the template index.html file and replaces them with the appropriate value or code:

- <encoreswftitle>
- <encoreswfobject>
- <encoreswfwidth>
- <encoreswfheight>

Note: <encoreswfobject> is the mandatory tag. Others are optional.

Create an HTML template

1. Create a folder on your desktop or in another location. Encore retains the name you give the folder for the template.
2. Create an HTML page in which you want to embed the SWF file. Name this HTML page index.html (index.html must have <encoreswfobject> tag).
3. Place the index.html file along with any other content it uses into the folder you created.
4. In Encore, click Import Template to select the HTML template.

[To the top](#)

Set up a local FMS server

You can set up a local Flash Media Server by modifying the script for local FMS server or writing a new script for adding a new CDN. When you set up a local Flash Media Server, ensure that you have the latest version of the Flash Media Server (3.0.2 or later).

1. Edit the script Sample Script.jsx at \Adobe Encore CS6\Required\FlashExportScripts with the following details:
 - streamingSiteURL—Enter the FMS server name.
 - ftpURL—Enter the FTP server name that you use to connect to the FMS server.
 - username—Enter your user name.
 - password—Enter your password.

[To the top](#)

Add a streaming server

- Write a script using the template provided (template.jsxx). Change its extension to .jsx. You can also rename the script file. You can use this template to add any Flash Media Streaming server in the future.

 Twitter™ and Facebook posts are not covered under the terms of Creative Commons.

[Legal Notices](#) | [Online Privacy Policy](#)

Security and additional content

- [Set copy-protection for replicated DVDs](#)
- [Set region coding for replicated DVDs](#)
- [Add ROM content to the disc](#)

Set copy-protection for replicated DVDs

[To the top](#)

Use copy-protection to limit or prevent duplication of your DVD content. Encore provides the industry-standard copy-protection schemes. To specify copy-protection settings for a project, use the Build panel. Copy-protection only works on professionally replicated discs. (See Replicating discs.)

Note: Copy-protection options are not available for Blu-ray discs or Flash projects.

1. Choose Window > Build, select DVD from the Format menu, and scroll down to the Copy Protection section of the DVD Settings.
2. Specify the copy-protection settings, and then close the Build panel and save the project:

CGMS Restricts the number of copies that can be made of your disc. Choose No Copies Are Allowed or One Copy Is Allowed to enable Content Scrambling System (CSS) and Macrovision®.

CSS Encrypts the video data, and then includes decryption keys that can only be read from the original disc. Duplicated copies do not include the decryption keys, so the video remains scrambled. This method prevents playing back digital copies of protected data. The encryption keys are processed at the replication level, not by Encore.

Macrovision An analog copy-protection scheme to prevent playing back recordings made from DVD to analog video devices, such as VCRs. Macrovision-encoded data sends electronic pulses to the analog device to disrupt recording sync, thereby scrambling the recorded image.

Note: Using Macrovision copy-protection requires that you pay a per-disc royalty. For more information, contact your replication service.

Set region coding for replicated DVDs

[To the top](#)

To control the countries in which your DVD will play, use region coding. Each region code corresponds to a particular country or geographical region. Often, only DVD players from a specific region can recognize the code for that region. DVDs coded for any other region will not play.

You can allow all regions to play your DVD, or only a select number of them. Region coding only works consistently on replicated DVDs. Some DVD players may read region coding correctly on projects written directly to DVD-R, while others will not. (See Replicating discs.)

Note: The All Regions setting is used for Blu-ray discs and Region Code options are not available for Flash output.

1. Choose Window > Build, select DVD from the Format menu, and scroll down to the Region Codes section of the DVD Settings.
2. All Regions is selected by default. Select Custom to deselect any number of region codes. When you close the Build panel and choose File > Save, your settings are saved with the project. The following table lists the available region codes.

Code	Region or country
1	Canada, United States, and U.S. territories
2	Japan, Europe, South Africa, and the Middle East
3	Southeast Asia, East Asia, and Hong Kong
4	Australia, Mexico, Central and South America

5	Russia, India, Pakistan, Africa, and North Korea
6	China
7	Reserved
8	International venues (airplanes, cruise ships, and so on)

[To the top](#)

Add ROM content to the disc

Although most projects typically contain multimedia content organized for viewing, you can use the large capacity of DVDs and Blu-ray discs to archive content or add supplemental content, such as related PDF files or software applications. You can include additional content on a typical video disc or you can create a ROM-only disc that contains only archived content (in other words, no menus or navigation).

ROM material is only available on personal computers. Furthermore, it's only available from the desktop, not from the video content of a disc. You can specify a folder of additional ROM content to be added to the disc when Encore builds your project.

Note: Only the files and folders inside the folder are added to the disc, not the folder.

1. To specify the location of the ROM content to include with the project, do one of the following:

- Choose File > Select DVD-ROM Folder. Navigate to the folder containing the ROM files and click OK.
- Choose Window > Build, select DVD from the Format menu, and in the DVD-ROM Content section, click Browse. Navigate to the folder containing the ROM files and click OK. (This setting also applies to Blu-ray projects.)

2. Choose File > Save to save the setting with your project.

Note: Even though the saved setting does not appear in the Blu-ray Settings section in the Build panel, Encore still outputs the DVD-ROM content with the project when you build a Blu-ray disc, folder, or image.

 Twitter™ and Facebook posts are not covered under the terms of Creative Commons.

[Legal Notices](#) | [Online Privacy Policy](#)

Keyboard shortcuts

Using keyboard shortcuts

Find keyboard shortcuts

Keys for working in the Project panel

Keys for selecting tools in the Tools panel

Keys for working in the Menu Viewer

Keys for working with text in menus and subtitles

Keys for working in the Slideshow Viewer

Keys for working in the Timeline Viewer

Keys for working in the Project Preview window

Keys for switching workspaces

Keys for resetting application defaults

Adobe® Encore® provides a set of keyboard shortcuts. Because many commands and buttons have keyboard equivalents, you can create a project with minimal use of the mouse.

Find keyboard shortcuts

[To the top](#)

- Do one of the following:
 - For a tool or button, hold the pointer over the tool or button until its tool tip appears. If available, the keyboard shortcut appears in the tool tip after the tool description.
 - For menu commands, look for the keyboard shortcut at the right of the command.
 - For keyboard shortcuts not shown in tool tips or on menus, refer to the following shortcut tables found in this chapter.

Keys for working in the Project panel

[To the top](#)

Result	Windows shortcut	Mac OS shortcut
Replace selected asset	cTRL + Alt + Shift + R	Command + Option + Shift + R
Open asset	Double-click	Double-click
Open selected asset	Enter or Return	Enter or Return
Select asset above current selection	Up Arrow	Up Arrow
Select asset below current selection	Down Arrow	Down Arrow
Duplicate selected asset	Ctrl + D	Command + D
Select all	Ctrl + A	Command + A
Deselect all	Ctrl + Shift + A	Command + Shift + A
Scroll to bottom of panel	End	End
Scroll to top of panel	Home	Home
New folder	Ctrl + Shift + N	Command + Shift + N
Open/close folders	Double-click	Double-click
Close selected folder	Left Arrow	Left Arrow
Open selected folder	Right Arrow	Right Arrow

Keys for selecting tools in the Tools panel

Result	Windows shortcut	Mac OS shortcut
Selection tool	V—press and release to change, hold to toggle	V—press and release to change, hold to toggle
Direct Select tool	A—press and release to change, hold to toggle	A—press and release to change, hold to toggle
Move tool	M—press and release to change, hold to toggle	M—press and release to change, hold to toggle
Rotate tool	R—press and release to change, hold to toggle	R—press and release to change, hold to toggle
Text tool	T—press and release to change, hold to toggle	T—press and release to change, hold to toggle
Vertical Text tool	Y—press and release to change, hold to toggle	Y—press and release to change, hold to toggle
Switch between vertical and horizontal text tools	Y or T	Y or T
Zoom tool	Z—press and release to change, hold to toggle	Z—click to change, hold to toggle

Keys for working in the Menu Viewer

This table lists only those shortcuts that are not displayed in menu commands or tool tips.

Result	Windows shortcut	Mac OS shortcut
Constrain aspect ratio while scaling	Shift-drag the bounding box handles	Shift-drag the bounding box handles
Constrain movement (including rotation) to 45°	Shift-drag	Shift-drag
Nudge selection 1 pixel down	Down Arrow	Down Arrow
Nudge selection 1 pixel up	Up Arrow	Up Arrow
Nudge selection 1 pixel left	Left Arrow	Left Arrow
Nudge selection 1 pixel right	Right Arrow	Right Arrow
Nudge selection 10 pixels down	Shift + Down Arrow	Shift + Down Arrow
Nudge selection 10 pixels left	Shift + Left Arrow	Shift + Left Arrow
Nudge selection 10 pixels right	Shift + Right Arrow	Shift + Right Arrow
Nudge selection 10 pixels up	Shift + Up Arrow	Shift + Up Arrow
Set link for selected button	Ctrl + L	Command + L
Set video background for motion menu	Alt-drag a video file from the Project panel	Option-drag a video file from the Project panel
Replace selected item	Alt-double-click an item in the Library panel	Option-double-click at item in the Library panel
Replace selected item	Alt-drag an item from the Library panel or	Option-drag an item from the Library panel

	Windows Explorer onto the item	or Mac OS Finder onto the item
Replace without scale	Ctrl-click the Replace button in the Library	Command-click the Replace button in the Library
Replace without scale	Ctrl + Alt-double-click an item in the Library	Command + Option-click an item in the Library
Replace without scale	Ctrl + Alt-drag from the Library onto the selected item	Command + Option-drag from the Library onto the selected item
Duplicate selected item	Alt-drag	Option-drag
Scale from center	Alt-drag the bounding box handles	Option-drag the bounding box handles
Show menu layers	Ctrl + right-click	Command + Control-click
Zoom in	Ctrl + . (period)	Command + . (period)
Zoom in	+ (plus)	+ (plus)
Zoom out	Ctrl + , (comma)	Command + , (comma)
Zoom out	- (minus)	- (minus)

Keys for working with text in menus and subtitles

[To the top](#)

Result	Windows shortcut	Mac OS shortcut
Enter text edit mode	Double-click text object	Double-click text object
Exit text edit mode	Esc	Esc
Move subtitle text in the Monitor tab when in text-editing mode	Ctrl-drag	Command-drag
Select word	Double-click	Double-click
Select line	Triple-click	Triple-click
Select paragraph	Click 4 times	Click 4 times
Select all text in text block	Click 5 times	Click 5 times
Select all text in text block	Ctrl + A	Command + A
Move cursor one character right or left	Right Arrow or Left Arrow	Right Arrow or Left Arrow
Move cursor one line up or down	Up Arrow or Down Arrow	Up Arrow or Down Arrow
Move cursor one word right or left	Ctrl + Right Arrow or Left Arrow	Command + Right Arrow or Left Arrow
Move cursor to next paragraph	Ctrl + Down Arrow	Command + Down Arrow
Move cursor to previous paragraph	Ctrl + Up Arrow	Command + Up Arrow
Move cursor to beginning of line	Home	Home
Move cursor to end of line	End	End
Move cursor to beginning of text	Ctrl + Home	Command + Home
Move cursor to end of text	Ctrl + End	Command + End
Increase selection of text	Shift-click	Shift-click

Increase selection by word	Double-click + drag	Double-click + drag
Increase selection by line	Triple-click + drag	Triple-click + drag
Increase selection by paragraph	Click 4 times + drag	Click 4 times + drag
Increase selection by character	Shift + Left Arrow or Right Arrow	Shift + Left Arrow or Right Arrow
Increase selection by word	Ctrl + Shift + Left Arrow or Right Arrow	Command + Shift + Left Arrow or Right Arrow
Increase selection by line	Ctrl + Shift + Up Arrow or Down Arrow	Command + Shift + Up Arrow or Down Arrow
Increase selection to beginning of text	Shift + Home	Shift + Home
Increase selection to end of text	Shift + End	Shift + End

Keys for working in the Slideshow Viewer

[To the top](#)

Result	Windows shortcut	Mac OS shortcut
Select last slide	End	End
Select first slide	Home	Home
Select next slide	Page Down	Page Down
Select previous slide	Page Up	Page Up
Select slide above	Up Arrow	Up Arrow
Select slide below	Down Arrow	Down Arrow
Select slide right	Right Arrow	Right Arrow
Select slide left	Left Arrow	Left Arrow
Zoom in	Ctrl + . (period)	Command + . (period)
Zoom In	+ (plus)	+ (plus)
Zoom out	Ctrl + , (comma)	Command + , (comma)
Zoom out	- (minus)	- (minus)

Keys for working in the Timeline Viewer

[To the top](#)

Result	Windows shortcut	Mac OS shortcut
Play/Pause (toggle)	Spacebar	Spacebar
Ripple delete	Shift + Backspace	Shift + Backspace
Slip audio or video independently	Alt-drag or Alt-click the audio or video portion of the clip with the Selection tool	Opt-drag or Opt-click the audio or video portion of the clip with the Selection tool
Move current-time indicator to end of last clip in timeline	End	End
Move current-time indicator to beginning of timeline	Home	Home

Move current-time indicator one frame left	Left Arrow	Left Arrow
Move current-time indicator one frame right	Right Arrow	Right Arrow
Go to next chapter point or edit point	Page Down	Page Down
Go to previous chapter point or edit point	Page Up	Page Up
Add a chapter point	Shift + 8	Shift + 8
Add a chapter point	* (asterisk on keypad)	* (asterisk on keypad)
Set a poster frame	Ctrl + Alt-drag from a chapter point	Command + Option-drag from a chapter point
Set a poster frame (prerequisite: chapter point is selected)	Shift + * (asterisk on keypad)	Shift + * (asterisk on keypad)
Set a poster frame (prerequisite: chapter point is selected)	Ctrl + Shift + 8	
Scroll timeline forward	Scroll wheel roll down	Scroll wheel roll down
Scroll timeline backward	Scroll wheel roll up	Scroll wheel roll up
Move current-time indicator one frame left	Ctrl + scroll wheel roll up	Command + scroll wheel roll up
Move current-time indicator one frame right	Ctrl + scroll wheel roll down	Command + scroll wheel roll down
Zoom in	Ctrl + . (period)	Command + . (period)
Zoom in	+ (plus) on numeric keypad	+ (plus) on numeric keypad
Zoom in	Click with zoom tool	Click with zoom tool
Zoom out	Alt-click with zoom tool	Option-click with zoom tool
Zoom out	- (minus) on numeric keypad	- (minus) on numeric keypad
Zoom out	Ctrl + , (comma)	Command + , (comma)

Keys for working in the Project Preview window

[To the top](#)

Result	Windows shortcut	Mac OS shortcut
Open Project Preview window	Shift + Spacebar	Shift + Spacebar
Activate current button	Enter	Enter
Activate a specific button	Press the number (1 through 9) of the button you want to activate.	Press the number (1 through 9) of the button you want to activate.
Activate End Action button	End	End
Activate Title button	Home	Home
Activate Menu button	Insert	none
Play/Pause	Spacebar	Spacebar
Go to previous chapter	Ctrl + Left Arrow	Command + Left Arrow
Go to next chapter	Ctrl + Right Arrow	Command + Right Arrow

Navigate buttons in a menu	Use the arrow keys to navigate up/down/right/left	Use the arrow keys to navigate up/down/right/left
Increase size of window and contents	Ctrl + = (equal sign) on main keyboard or + (plus sign) on numeric keypad	Command + = (equal sign) on main keyboard or + (plus sign) on numeric keypad
Decrease size of window and contents	Ctrl + - (hyphen) on main keyboard or - (minus sign) on numeric keypad	Command + - (hyphen) on main keyboard or - (minus sign) on numeric keypad

Keys for switching workspaces

[To the top](#)

Result	Windows shortcut	Mac OS shortcut
Switch to first workspace in Workspace menu	Alt + Shift + 1	Option + Shift + 1
Switch to second workspace in Workspace menu	Alt + Shift + 2	Option + Shift + 2
Switch to third workspace in Workspace menu	Alt + Shift + 3	Option + Shift + 3
Switch to fourth workspace in Workspace menu	Alt + Shift + 4	Option + Shift + 4
Switch to fifth workspace in Workspace menu	Alt + Shift + 5	Option + Shift + 5
Switch to sixth workspace in Workspace menu	Alt + Shift + 6	Option + Shift + 6
Switch to seventh workspace in Workspace menu	Alt + Shift + 7	Option + Shift + 7
Switch to eighth workspace in Workspace menu	Alt + Shift + 8	Option + Shift + 8
Switch to ninth workspace in Workspace menu	Alt + Shift + 9	Option + Shift + 9

Keys for resetting application defaults

[To the top](#)

Result	Windows shortcut	Mac OS shortcut
Reset keys in registry file	Ctrl + Shift while Encore starts	Drag the Preferences file to the trash and restart Encore.

 Twitter™ and Facebook posts are not covered under the terms of Creative Commons.

[Legal Notices](#) | [Online Privacy Policy](#)